

400W SURFACE MOUNT TRANSIENT VOLTAGE SUPPRESSOR

Features

- 400W peak pulse power capability with a 10/1000us waveform, repetition rate (duty cycle): 0.01%.
- Excellent clamping capability.
- Low incremental surge resistance.
- Glass passivated chip junction.
- Ultra high-speed switching.

Mechanical data

- Epoxy: UL94-V0 rated flame retardant
- Case : Molded plastic, DO-214AC / SMA
- Terminals : Solder plated, solderable per MIL-STD-750, Method 2026
- Polarity : Indicated by cathode band
- Weight : 0.002 ounce, 0.055 gram

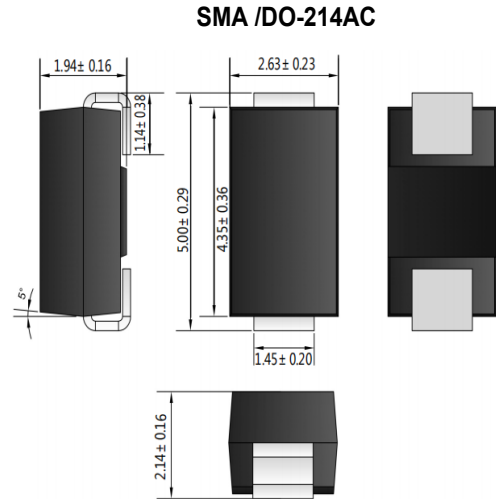

Dimensions in millimeters

Maximum ratings and electrical characteristics

Rating at 25°C ambient temperature unless otherwise specified. Single phase, half wave, 60Hz, resistive or inductive load.
For capacitive load, derate current by 20%.

Parameter	Conditions	Symbol	P4SMA series	UNIT
Peak power dissipation	with a 10/1000us waveform, note 1	P_{PPM}	400	W
Peak forward surge current	8.3ms single half sine-wave superimposed on rate load (JEDEC method), note 2	I_{FSM}	40	A
Steady state power dissipation	on infinite heatsink at $T_L = 75^\circ\text{C}$	P_D	1.0	W
Peak pulse current	with a 10/1000us waveform, note 1	I_{PPM}	See Table 1	A
Maximum instantaneous forward voltage	at 25A for unidirectional only, note 3	V_F	3.5 / 5.0	V
Operating temperature		T_J	-55 ~ +150	°C
Storage temperature		T_{STG}	-55 ~ +150	°C

Notes : 1. Non-repetitive current pulse, per Fig. 3 and derated above $T_A=25^\circ\text{C}$ per Fig. 2.
2. Measured on 8.3 ms single half sine-wave or equivalent square wave, duty cycle=4 pulses per minute maximum.
3. $V_F < 3.5\text{V}$ for devices of $V_{BR} < 200\text{V}$ and $V_F < 5.0\text{V}$ for devices of $V_{BR} > 201\text{V}$.

Electrical Characteristics (@T_A=25°C unless otherwise specified) Table 1

Part No.	Reverse Stand-off Voltage	Breakdown Voltage		Test Current	Peak Forward Surge Current	Maximum Clamping Voltage @I _{PP}		Maximum Leakage Current	Marking Code	
	V _{RWM}	V _{BR Min}	V _{BR Max}	I _T	I _{FSM}	V _C	I _{PP}	I _R @V _{RWM}	UNI	BI
	Volts	Volts	Volts	mA	A	Volts	A	uA		
P4SMA6.8(C)A	5.8	6.46	7.14	10	40	10.5	38.1	500	6V8A	6V8C
P4SMA7.5(C)A	6.4	7.13	7.88	10	40	11.3	35.40	500	7V5A	7V5C
P4SMA8.2(C)A	7.0	7.79	8.61	10	40	12.1	33.06	200	8V2A	8V2C
P4SMA9.1(C)A	7.8	8.65	9.56	1.0	40	13.4	29.85	50	9V1A	9V1C
P4SMA10(C)A	8.6	9.50	10.50	1.0	40	14.5	27.59	10	10A	10C
P4SMA11(C)A	9.4	10.45	11.55	1.0	40	15.6	25.64	5	11A	11C
P4SMA12(C)A	10.2	11.40	12.60	1.0	40	16.7	23.95	5	12A	12C
P4SMA13(C)A	11.1	12.35	13.65	1.0	40	18.2	21.98	5	13A	13C
P4SMA15(C)A	12.8	14.25	15.75	1.0	40	21.2	18.87	5	15A	15C
P4SMA16(C)A	13.6	15.20	16.80	1.0	40	22.5	17.78	5	16A	16C
P4SMA18(C)A	15.3	17.10	18.90	1.0	40	25.2	15.87	5	18A	18C
P4SMA20(C)A	17.1	19.00	21.00	1.0	40	27.7	14.44	5	20A	20C
P4SMA22(C)A	18.8	20.90	23.10	1.0	40	30.6	13.07	5	22A	22C
P4SMA24(C)A	20.5	22.80	25.20	1.0	40	33.2	12.05	5	24A	24C
P4SMA27(C)A	23.1	25.65	28.35	1.0	40	37.5	10.67	5	27A	27C
P4SMA30(C)A	25.6	28.50	31.50	1.0	40	41.4	9.66	5	30A	30C
P4SMA33(C)A	28.2	31.35	34.65	1.0	40	45.7	8.75	5	33A	33C
P4SMA36(C)A	30.8	34.20	37.80	1.0	40	49.9	8.02	5	36A	36C
P4SMA39(C)A	33.3	37.05	40.95	1.0	40	53.9	7.42	5	39A	39C
P4SMA43(C)A	36.8	40.85	45.15	1.0	40	59.3	6.75	5	43A	43C
P4SMA47(C)A	40.2	44.65	49.35	1.0	40	64.8	6.17	5	47A	47C
P4SMA51(C)A	43.6	48.45	53.55	1.0	40	70.1	5.71	5	51A	51C
P4SMA56(C)A	47.8	53.20	58.80	1.0	40	77.0	5.19	5	56A	56C
P4SMA62(C)A	53.0	58.90	65.10	1.0	40	85.0	4.71	5	62A	62C
P4SMA68(C)A	58.1	64.60	71.40	1.0	40	92.0	4.35	5	68A	68C
P4SMA75(C)A	64.1	71.25	78.75	1.0	40	103.0	3.88	5	75A	75C
P4SMA82(C)A	70.1	77.90	86.10	1.0	40	113.0	3.54	5	82A	82C
P4SMA91(C)A	77.8	86.45	95.55	1.0	40	125.0	3.20	5	91A	91C
P4SMA100(C)A	85.5	95.00	105.00	1.0	40	137.0	2.92	5	100A	100C
P4SMA110(C)A	94.0	104.50	115.50	1.0	40	152.0	2.63	5	110A	110C
P4SMA120(C)A	102.0	114.00	126.00	1.0	40	165.0	2.42	5	120A	120C
P4SMA130(C)A	111.0	123.50	136.50	1.0	40	179.0	2.23	5	130A	130C
P4SMA150(C)A	128.0	142.50	157.50	1.0	40	207.0	1.93	5	150A	150C
P4SMA160(C)A	136.0	152.00	168.00	1.0	40	219.0	1.83	5	160A	160C
P4SMA170(C)A	145.0	161.50	178.50	1.0	40	234.0	1.71	5	170A	170C

Electrical Characteristics (@T_A=25°C unless otherwise specified) Table 1 (Cont'd)

Part No.	Reverse Stand-off Voltage	Breakdown Voltage		Test Current	Peak Forward Surge Current	Maximum Clamping Voltage @I _{PP}		Maximum Leakage Current	Marking Code	
	V _{RWM}	V _{BRMin}	V _{BRMax}	I _T	I _{FSM}	V _C	I _{PP}	I _R @V _{RWM}		
	Volts	Volts	Volts	mA	A	Volts	A	uA	UNI	BI
P4SMA180(C)A	154.0	171.00	189.00	1.0	40	246.0	1.63	5	180A	180C
P4SMA200(C)A	171.0	190.00	210.00	1.0	40	274.0	1.46	5	200A	200C
P4SMA220(C)A	185.0	209.00	231.00	1.0	40	328.0	1.22	5	220A	220C
P4SMA250(C)A	214.0	237.50	262.50	1.0	40	344.0	1.16	5	250A	250C
P4SMA300(C)A	256.0	285.00	315.00	1.0	40	414.0	0.97	5	300A	300C
P4SMA350(C)A	299.3	332.50	367.50	1.0	40	482.0	0.83	5	350A	350C
P4SMA380(C)A	324.9	361.00	399.00	1.0	40	524.4	0.76	5	380A	380C
P4SMA400(C)A	342.0	380.00	420.00	1.0	40	552.0	0.72	5	400A	400C
P4SMA440(C)A	376.2	418.00	462.00	1.0	40	607.0	0.66	5	440A	440C
P4SMA500(C)A	427.5	475.00	525.00	1.0	40	690.0	0.58	5	500A	500C
P4SMA520(C)A	444.6	494.00	546.00	1.0	40	717.6	0.56	5	520A	520C
P4SMA550(C)A	470.3	522.50	577.50	1.0	40	759.0	0.53	5	550A	550C
P4SMA600(C)A	513.0	570.00	630.00	1.0	40	828.0	0.48	5	600A	600C

Note 1. Suffix 'C' denotes bi-directional devices. Suffix 'A' denotes 5% tolerance devices, no suffix denotes 10% tolerance devices.
 2. For bi-directional types having V_{RWM} of 10 volts and less, the I_R limit is doubled.

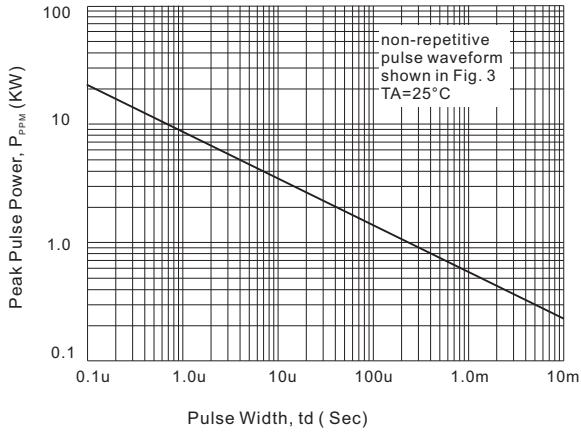
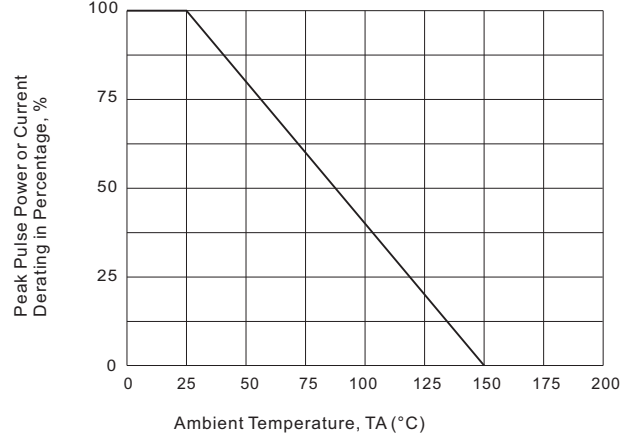
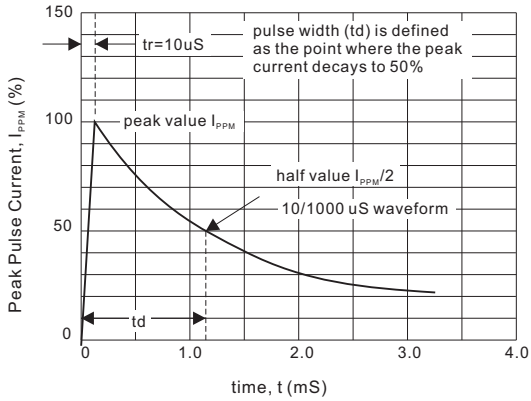
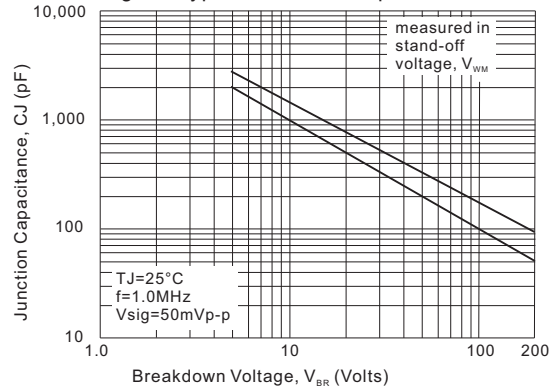
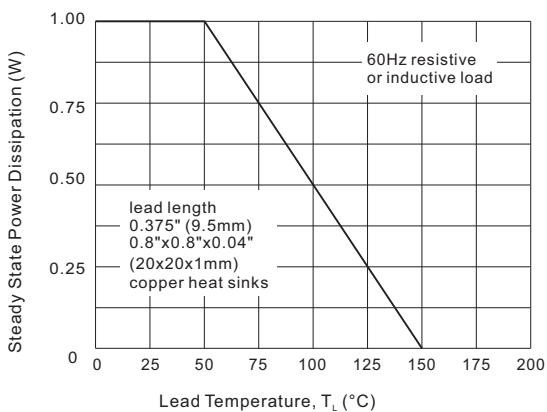
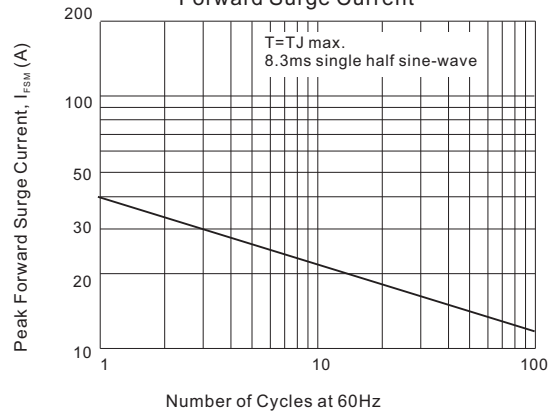
Rating and characteristic curves
Fig.1 - Peak Pulse Power Rating Curve

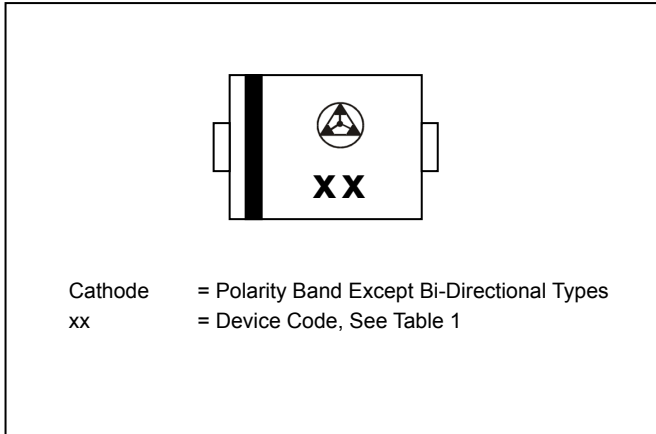
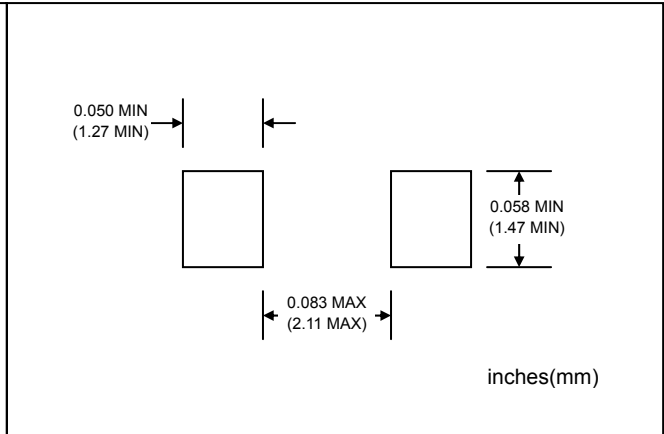
Fig.2 - Pulse Derating Curve

Fig.3 - Pulse Waveform

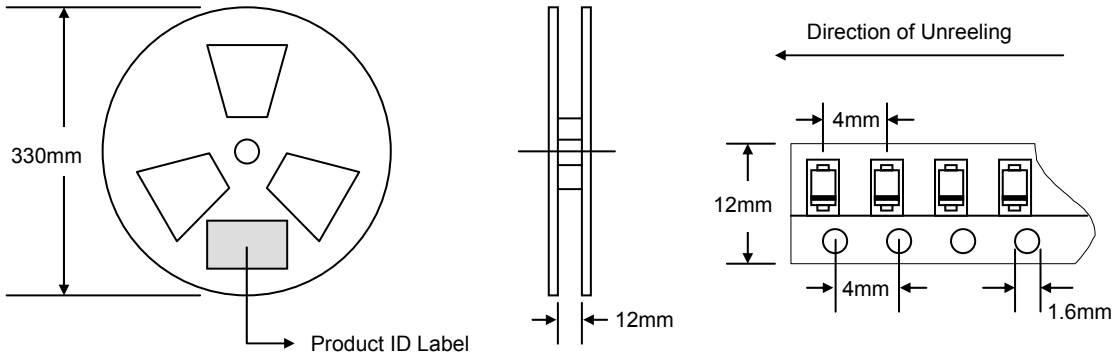
Fig.4 - Typical Junction Capacitance

Fig.5 - Steady State Power Derating Curve

Fig.6 - Maximum Non-Repetitive Forward Surge Current

MARKING INFORMATION

RECOMMENDED FOOTPRINT

PACKAGING INFORMATION

TAPE & REEL



Reel Diameter (mm)	Quantity (PCS)	Inner Box Size L x W x H (mm)	Quantity (PCS)	Carton Size L x W x H (mm)	Quantity (PCS)	Approx. Gross Weight (KG)
330	5,000	340 x 337 x 45	10,000	370 x 370 x 420	80,000	14.0

Disclaimer

DACO Semiconductor reserves the right to make modifications, enhancements, improvements, corrections, or other changes to this document and any product described herein without prior notice. For the most up-to-date version, please visit our website.

DACO Semiconductor makes no warranty, representation, or guarantee regarding the suitability of its products for any particular purpose, nor does DACO Semiconductor assume any liability arising out of the application or use of any product or circuit, and specifically disclaims any liability, including without limitation special, consequential or incidental damages.

Purchasers are responsible for its products and applications using DACO Semiconductor products, including compliance with all laws, regulations, and safety requirements or standards, regardless of any support or application information provided by DACO Semiconductor. "Typical" parameters that may be provided in DACO Semiconductor datasheets and/or specifications can and do vary in different applications and actual performance may vary over time. All operating parameters, including "Typical" must be validated for each customer application by the customer's technical experts.

DACO Semiconductor products are not designed, authorized, or warranted to be suitable for use in life support, life-critical or safety-critical systems, or equipment, nor in applications where failure or malfunction of DACO Semiconductor's product can reasonably be expected to result in personal injury, death or severe property or environmental damage. DACO Semiconductor accepts no liability for the inclusion and/or use of DACO Semiconductor's products in such equipment or applications and therefore such inclusion and/or use is at the customer's own risk.

Purchasers who buy or use DACO Semiconductor products for any unintended or unauthorized applications are required to indemnify and absolve DACO Semiconductor, its suppliers, and distributors from any claims, costs, damages, expenses, and reasonable attorney fees arising out of, directly or indirectly, any claim of personal injury or death associated with such unintended or unauthorized use, even if such claim alleges that DACO Semiconductor was negligent regarding the design or manufacture of the part.

No part of this publication may be reproduced or transmitted in any form or by any means, electronic or mechanical, including photocopying and recording, or by any information storage and retrieval system, or otherwise, without the prior written permission of DACO Semiconductor Co., Ltd.