



LOW VF SCHOTTKY DIODE MODULE TYPE

Features

- High Surge Capability
- Isolation Type Package
- Electrically Isolation base plate

800 Amp Rectifier
35 Volts

HEAVY THREE TOWER

Maximum Ratings

Operating Temperature: -40 °C to +100 °C
Storage Temperature: -40 °C to +150 °C

Part Number	Maximum Recurrent Peak Reverse Voltage	Maximum RMS Voltage	Maximum DC Blocking Voltage
MBRTA80035(R)L	35V	25V	35V

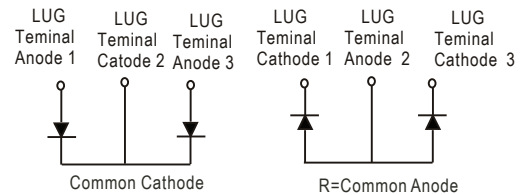
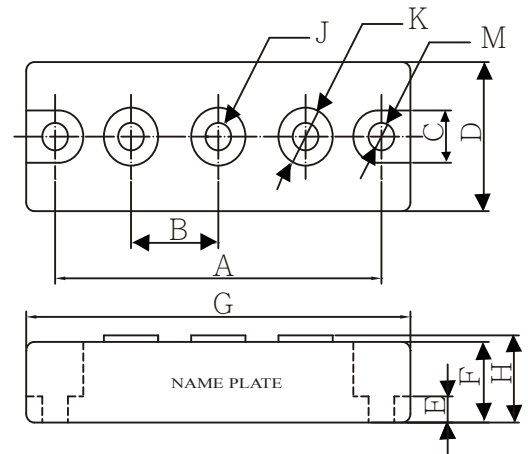

Electrical Characteristics @ 25 °C Unless Otherwise Specified

Average Forward Current (Per pkg)	$I_{F(AV)}$	800A	$T_C=100^{\circ}C$
Peak Forward Surge Current (Per leg)	I_{FSM}	6000A	8.3ms, half sine
Maximum Instantaneous Forward Voltage (Per leg)	V_F	0.60V	$I_{FM}=400 A; T_J=25^{\circ}C$
Maximum Instantaneous Reverse Current At Rated DC Blocking Voltage (Per leg)	I_R	3mA 350mA	$T_J= 25^{\circ}C$ $T_J= 100^{\circ}C$
Maximum Thermal Resistance Junction To Case (Per leg)	$R_{\theta j c}$	0.25 °C/W	

NOTE :
(1) Pulse Test: Pulse Width 300 μ sec. Duty Cycle < 2%

DIM	DIMENSIONS			
	Inches		Millimeters	
	Min	Max	Min	Max
A	3.150	NOM	80.01	NOM
B	.872	.892	22.15	22.65
C	.465	.479	11.82	12.18
D	1.337	1.356	33.95	34.45
E	.230	.234	5.84	6.16
F	.725	REF	18.42	REF
G	3.668	3.768	93.17	95.71
H	---	.791	---	20.10
J	1/4-20 UNC FULL			
K	.509	.538	12.92	13.68
M	.238	.258	6.05	6.55



Figure .1-Typical Forward Characteristics

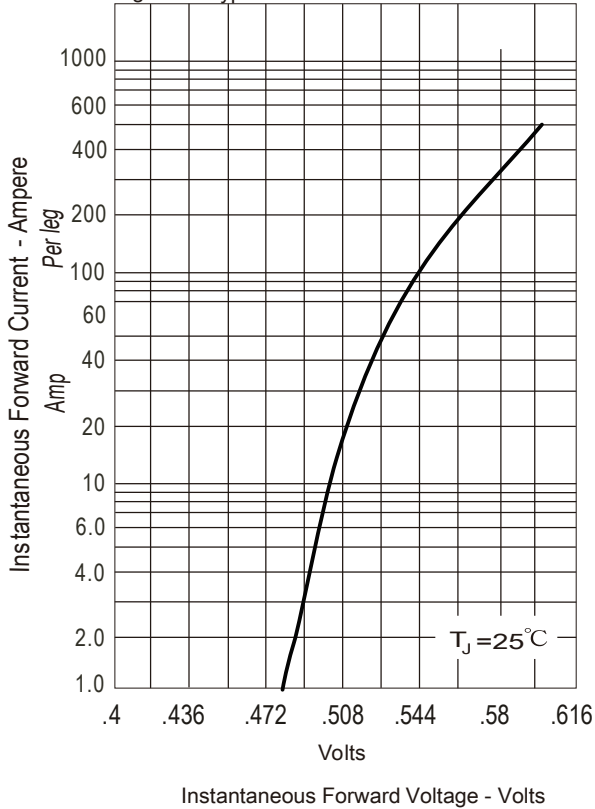

Figure .2-Forward Derating Curve

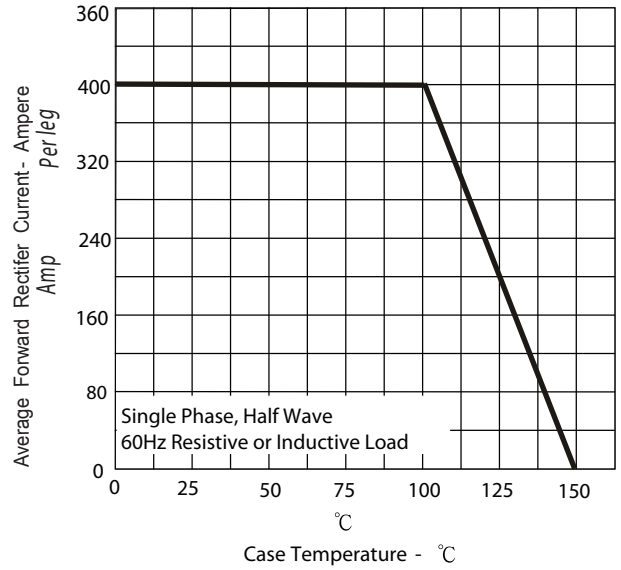

Figure .4-Typical Reverse Characteristics

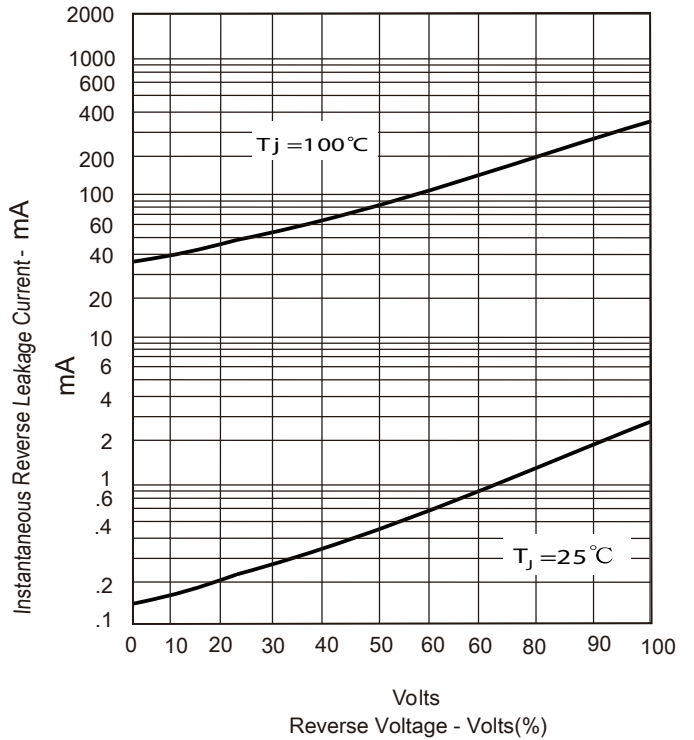
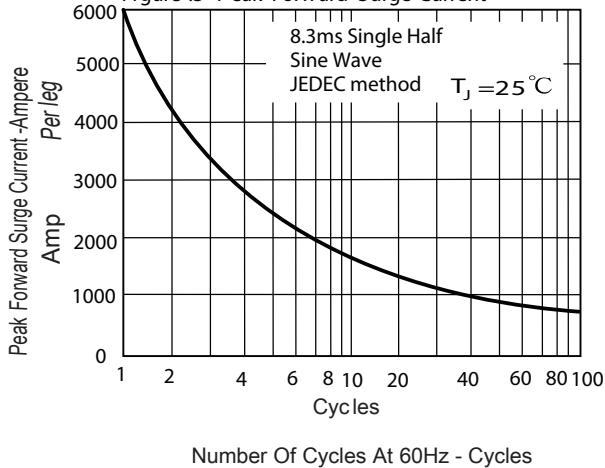

Figure .3- Peak Forward Surge Current





Disclaimer

DACO Semiconductor reserve the right to make modifications, enhancements, improvements, corrections or other changes without further notice to this document and any product described herein.

DACO Semiconductor makes no warranty, representation or guarantee regarding the suitability of its products for any particular purpose, nor does DACO Semiconductor assume any liability arising out of the application or use of any product or circuit, and specifically disclaims any and all liability, including without limitation special, consequential or incidental damages.

Purchasers is responsible for its products and applications using DACO Semiconductor products, including compliance with all laws, regulations and safety requirements or standards, regardless of any support or applications information provided by DACO Semiconductor. "Typical" parameters which may be provided in DACO Semiconductor data sheets and/or specifications can and do vary in different applications and actual performance may vary over time. All operating parameters, including "Typicals" must be validated for each customer application by customer's technical experts.

DACO Semiconductor products are not designed, authorized or warranted to be suitable for use in life support, life-critical or safety-critical systems or equipment, nor in applications where failure or malfunction of DACO Semiconductor's product can reasonably be expected to result in personal injury, death or severe property or environmental damage. DACO Semiconductor accept no liability for inclusion and/or use of DACO Semiconductor's products in such equipment or applications and therefore such inclusion and/or use is at the customer's own risk.

Purchasers buy or use DACO Semiconductor products for any such unintended or unauthorized application, Purchasers shall indemnify and hold DACO Semiconductor and its suppliers and distributors harmless against all claims, costs, damages, and expenses, and reasonable attorney fees arising out of, directly or indirectly, any claim of personal injury or death associated with such unintended or unauthorized use, even if such claim alleges that DACO Semiconductor was negligent regarding the design or manufacture of the part.

No part of this publication may be reproduced or transmitted in any form or by any means, electronic or mechanical, including photocopying and recording, or any information storage or retrieval system, or otherwise, without the prior written permission of DACO Semiconductor Co., Ltd.