

SiC MOSFET Power Module

Features

- ◆ $V_{DSS} = 1200V$
- ◆ $R_{DS(ON)}$ typ. $11m\Omega @ V_{GS} = 18V$
- ◆ SiC-Schottky diode
- ◆ High speed switching with low capacitances
- ◆ Easy to parallel and simple to drive
- ◆ Real Kelvin Source Connection
- ◆ Pb Free & RoHS Compliant
- ◆ Electrically Isolation base plate

Preliminary

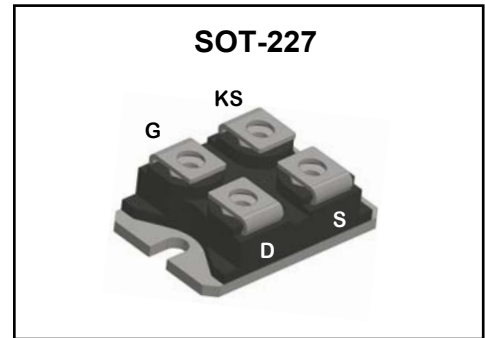
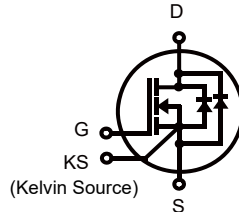

Dimensions in inches and (millimeters)

Applications

- ◆ Solar Inverters
- ◆ UPS
- ◆ Motor Drive
- ◆ Induction heating
- ◆ Switch Mode Power Supplies
- ◆ Battery Chargers
- ◆ DC/DC Converters

Absolute Maximum Ratings ($T_c=25^\circ C$ unless otherwise noted)

Parameter	Symbol	Ratings	Unit	
Drain-Source Voltage	V_{DS}	1200	V	
Gate-Source Voltage (dynamic)	$V_{GS(max)}$	-10/+23	V	
Gate-Source Voltage (static)	$V_{GS(OP)}$	-4/+18	V	
Drain Current-Continuous	I_D	@ $T_c = 25^\circ C$ @ $T_c = 100^\circ C$	172 120	A
Drain Current-Pulsed	I_{DM}	@ $T_c = 25^\circ C$	344	A
Maximum Power Dissipation	P_D	714	W	
Storage Temperature Range	T_{STG}	-40 to +125	$^\circ C$	
Operating Junction Temperature Range	T_{VJ}	-40 to +175	$^\circ C$	
Thermal Resistance, Junction-to-Case	$R_{\theta JC}$	0.21	$^\circ C/W$	
Isolation Voltage (A.C. 1 minute) between All Terminals and Baseplate	V_{iso}	2500	V	
Mounting torque (M4 Screw)	To heatsink To terminals	M_d	1.3 1.1	N_m

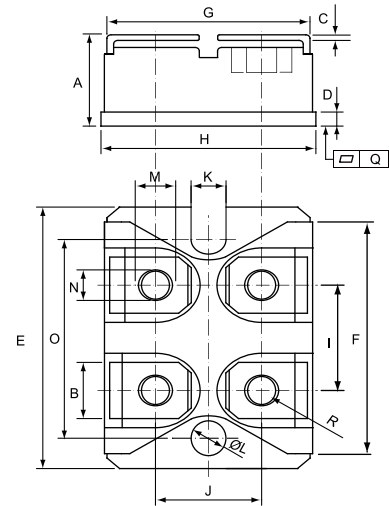

	DIMENSIONS			
	INCHES		MM	
	MIN	MAX	MIN	MAX
A	0.460	0.483	11.68	12.28
B	0.307	0.323	7.80	8.20
C	0.030	0.033	0.75	0.85
D	0.071	0.081	1.80	2.05
E	1.488	1.504	37.80	38.20
F	1.248	1.260	31.70	32.00
G	0.917	0.957	23.30	24.30
H	0.996	1.008	25.30	25.60
I	0.579	0.602	14.70	15.30
J	0.492	0.516	12.50	13.10
K	0.161	0.169	4.10	4.30
L	0.161	0.169	4.10	4.30
M	0.181	0.197	4.60	5.00
N	0.165	0.181	4.20	4.60
O	1.181	1.197	30.00	30.40
Q	-0.002	0.004	-0.05	0.10
R	M4*8			

Electrical Characteristics @ $T_{VJ} = 25^{\circ}\text{C}$ (unless otherwise specified)

Parameter	Symbol	Conditions	Min.	Typ.	Max.	Unit	
OFF Characteristics							
Drain-Source Breakdown Voltage	BV_{DSS}	$V_{GS} = 0V, I_{DS} = 0.2mA$	1200	-	-	V	
Zero Gate Voltage Drain Current	I_{DSS}	$V_{GS} = 0V, V_{DS} = 1200V$	-	-	200	μA	
Gate-Body Leakage	I_{GSS}	$V_{GS} = 20V, V_{DS} = 0V$	-	-	500	nA	
ON Characteristics							
Gate Threshold Voltage	$V_{GS(th)}$	$V_{DS} = V_{GS}, I_{DS} = 8mA$	2.0	2.9	4.1	V	
Drain-Source On-State Resistance	$R_{DS(on)}$	$V_{GS} = 18V, I_{DS} = 100A$	-	11	14.3	m Ω	
Gate Resistance	$R_{G(int)}$	Internal gate resistor	$T_{VJ} = 25^{\circ}\text{C}$	-	11.24	Ω	
Dynamic Characteristics							
Input Capacitance	C_{iss}	$V_{DS} = 800V$ $V_{GS} = 0V$ $V_{AC} = 1V$ Freq. = 100KHz	-	6.61	-	nF	
Output Capacitance	C_{oss}		-	0.49	-		
Reverse Transfer Capacitance	C_{rss}		-	0.04	-		
Total Gate Charge	Q_g	$V_{DS} = 600V$ $V_{GS} = -4V/+18V$ $I_{DS} = 120A$	-	216	-	nC	
Gate to Source Charge	Q_{gs}		-	148	-		
Gate to Drain Charge	Q_{gd}		-	30	-		
Switching Characteristics							
Turn-On Delay Time	$t_{d(on)}$	$V_{DD} = 600V$ $V_{GS} = -4/+18V$ $I_{DS} = 120A$ $R_{G(on)} = 2.2\Omega$ $R_{G(off)} = 2.2\Omega$	$T_{VJ} = 25^{\circ}\text{C}$	-	95	-	ns
			$T_{VJ} = 150^{\circ}\text{C}$	-	85	-	
Rise Time	t_r		$T_{VJ} = 25^{\circ}\text{C}$	-	125	-	
			$T_{VJ} = 150^{\circ}\text{C}$	-	115	-	
Turn-Off Delay Time	$t_{d(off)}$		$T_{VJ} = 25^{\circ}\text{C}$	-	181	-	
			$T_{VJ} = 150^{\circ}\text{C}$	-	206	-	
Fall Time	t_f		$T_{VJ} = 25^{\circ}\text{C}$	-	31	-	
			$T_{VJ} = 150^{\circ}\text{C}$	-	42	-	
Turn-On Switching Energy	E_{on}		$T_{VJ} = 25^{\circ}\text{C}$	-	3.9	-	mJ
			$T_{VJ} = 150^{\circ}\text{C}$	-	4.2	-	
Turn-Off Switching Energy	E_{off}	$T_{VJ} = 25^{\circ}\text{C}$	-	5	-		
		$T_{VJ} = 150^{\circ}\text{C}$	-	6.1	-		
SiC Schottky Diode Characteristics at $T_J = 25^{\circ}\text{C}$, unless otherwise specified							
Continuous Diode Fwd Current	I_{SDC}	$V_{GS} = 0V$	-	120	-	A	
Drain-Source Reverse Voltage	V_{SD}	$I_{SD} = 75A, V_{GS} = 0V$	-	1.8	-	V	
MOSFET Forward Recovery Charge	Q_{rr}	$V_{DD} = 600V$ $I_{DS} = 120A$ $V_{GS} = -4/+18V$ $di/dt = 1900 A/\mu s$	$T_{VJ} = 25^{\circ}\text{C}$	-	1028	-	nC
			$T_{VJ} = 150^{\circ}\text{C}$	-	3009	-	
MOSFET Peak Forward Recovery Current	I_{rrm}		$T_{VJ} = 25^{\circ}\text{C}$	-	24	-	A
			$T_{VJ} = 150^{\circ}\text{C}$	-	36	-	
MOSFET Reverse Recovery Time	T_{rr}		$T_{VJ} = 25^{\circ}\text{C}$	-	89	-	ns
			$T_{VJ} = 150^{\circ}\text{C}$	-	130	-	

Notes:
1. Pulse Test: Pulse Width $\leq 300 \mu s$, Duty Cycle $> 2\%$.

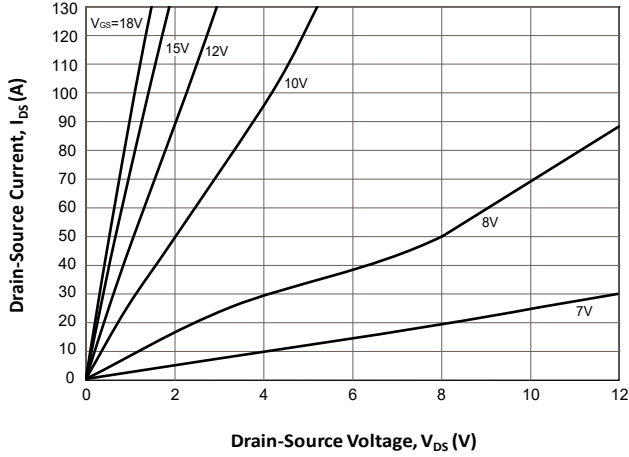
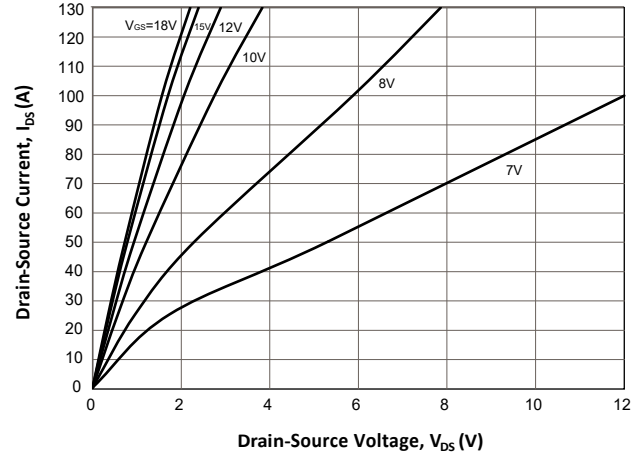
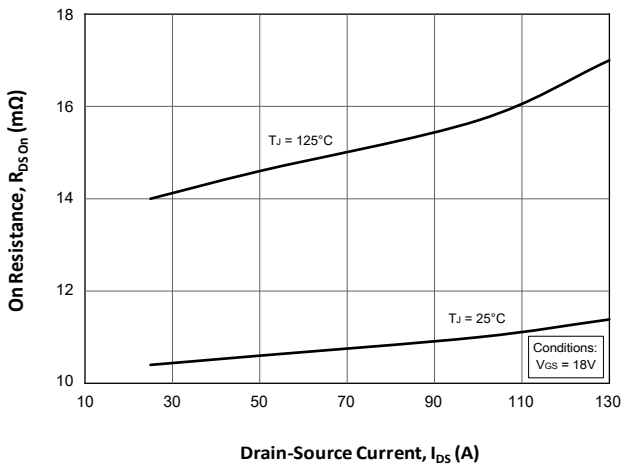
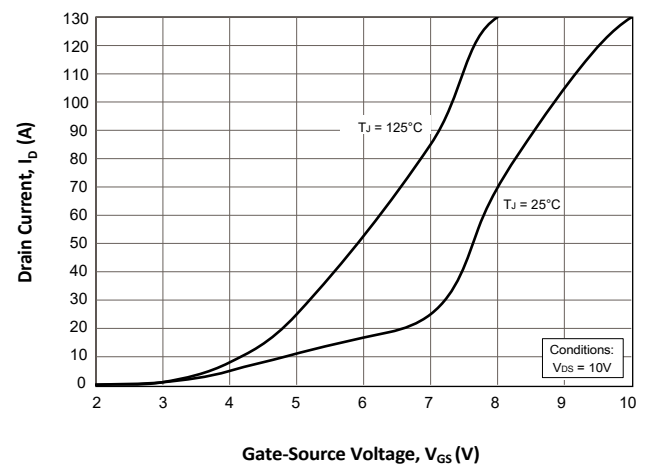
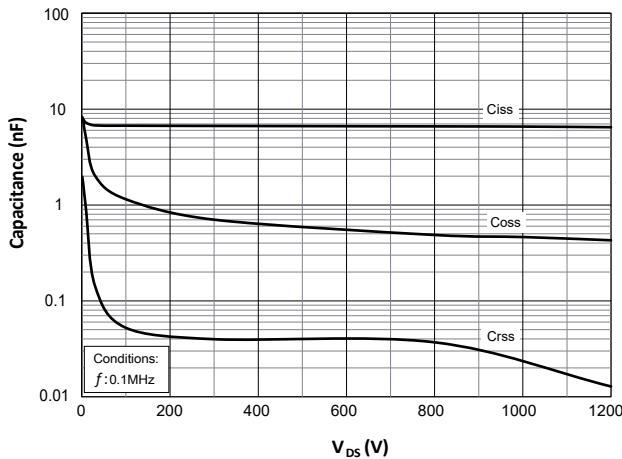
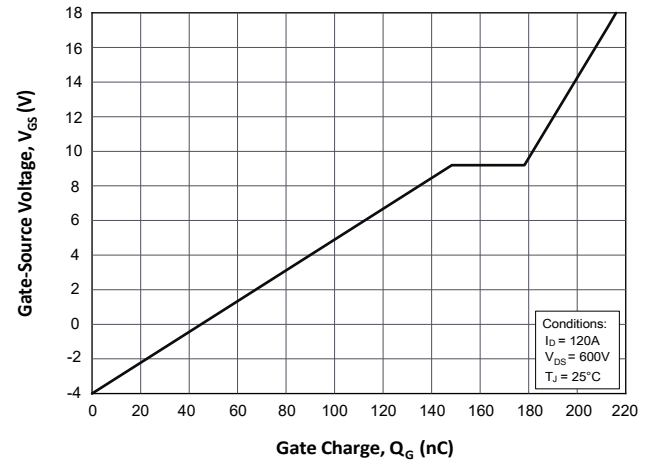
Typical Characteristics
Fig.1 Output Characteristics at $T_J = 25^\circ\text{C}$

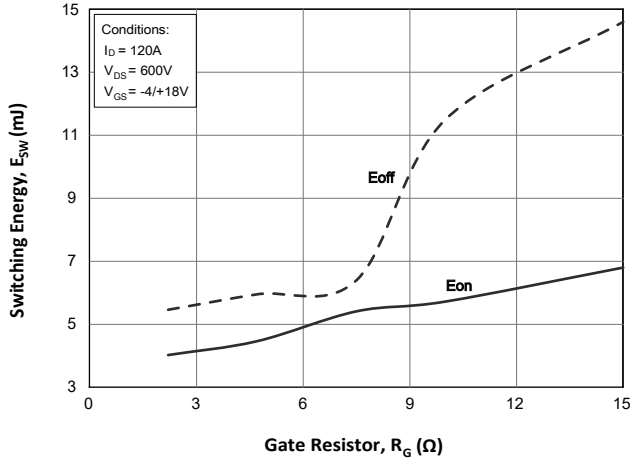
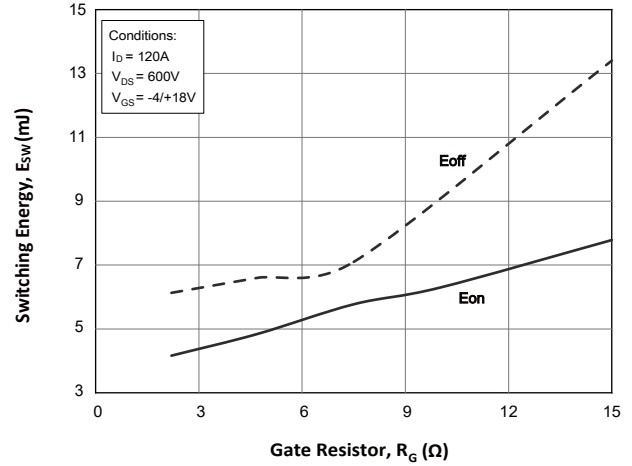
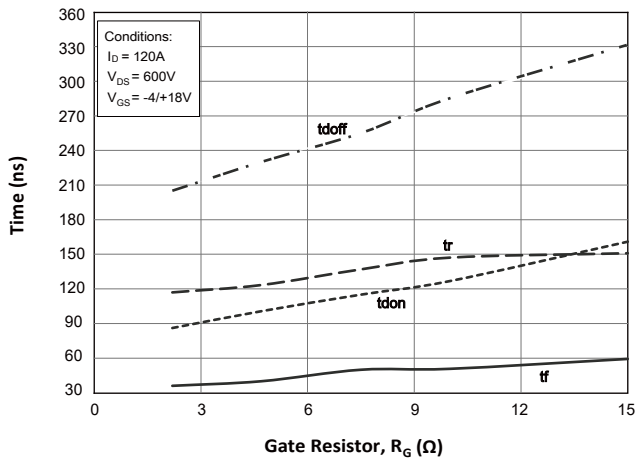
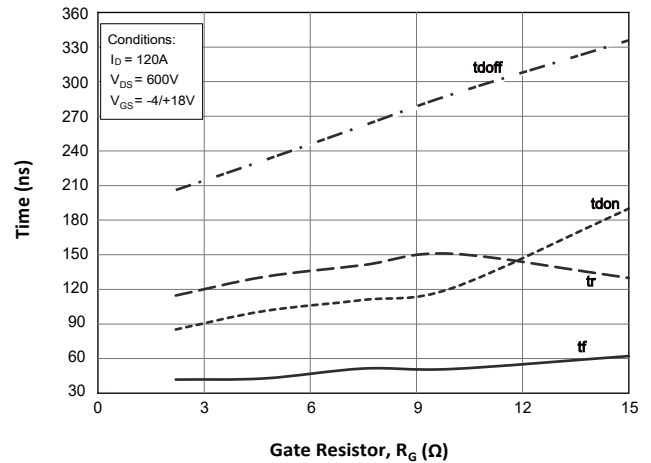
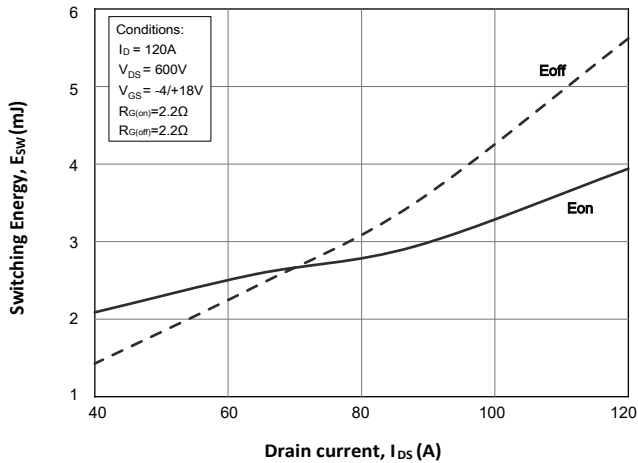
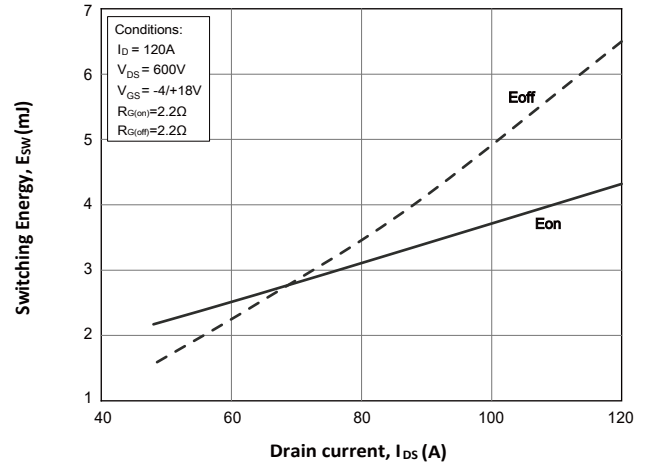
Fig.2 Output Characteristics at $T_J = 125^\circ\text{C}$

Fig.3 Drain Source on Resistance

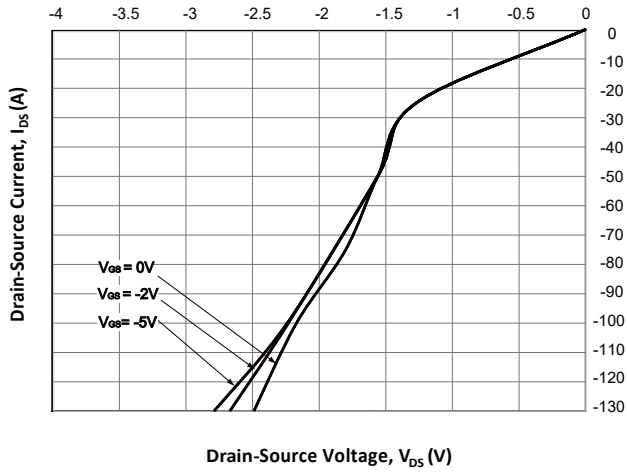
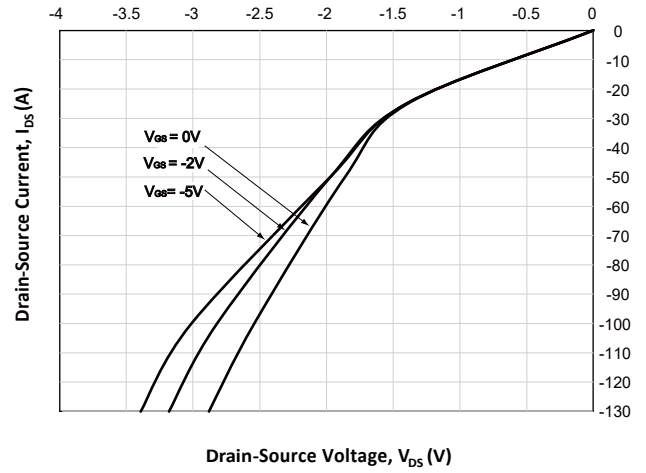
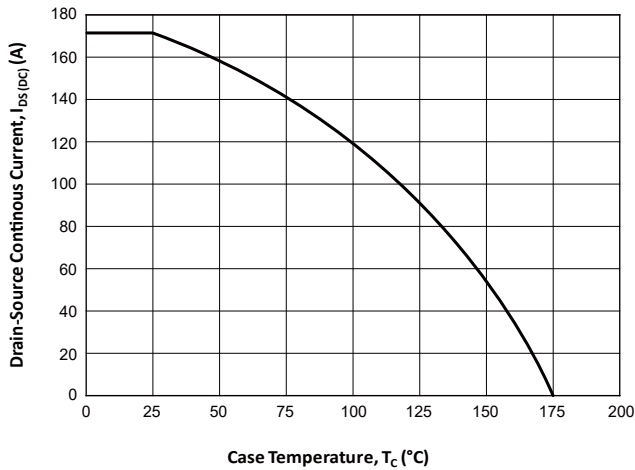
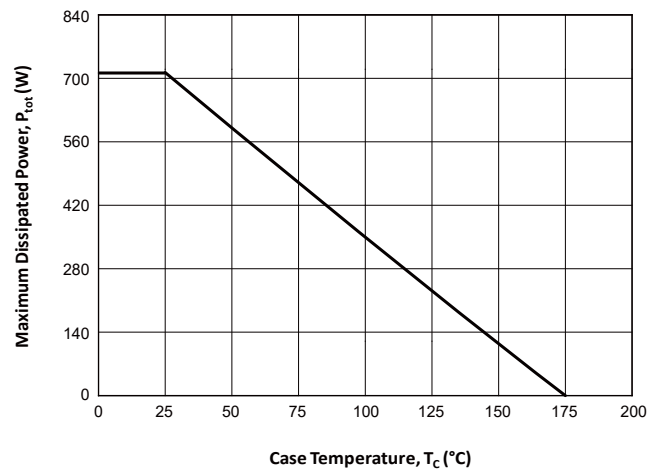
Fig.4 Transfer Characteristics

Fig.5 Capacitances vs. Drain-Source Voltage

Fig.6 Gate Charge Characteristics

Typical Characteristics
Fig.7 Switching losses vs R_G change $T_J=125^\circ\text{C}$

Fig.8 Switching losses vs R_G change $T_J=150^\circ\text{C}$

Fig.9 Switching Timer vs R_G Change $T_J=125^\circ\text{C}$

Fig.10 Switching Timer vs R_G Change $T_J=150^\circ\text{C}$

Fig.11 Clamped Inductive Switching Energy vs. Drain Current $T_J=125^\circ\text{C}$

Fig.12 Clamped Inductive Switching Energy vs. Drain Current $T_J=150^\circ\text{C}$

Typical Characteristics

Fig.13 SiC Schottky Diode curves $T_J = 25^\circ\text{C}$

Fig.14 SiC Schottky Diode curves $T_J = 125^\circ\text{C}$

Fig.15 Continuous Drain Current (MOSFET) vs. Case Temperature

Fig.16 Max. Power Dissipation (MOSFET) Derating vs. Case Temperature

Disclaimer

DACO Semiconductor reserves the right to make modifications, enhancements, improvements, corrections, or other changes to this document and any product described herein without prior notice. For the most up-to-date version, please visit our website.

DACO Semiconductor makes no warranty, representation, or guarantee regarding the suitability of its products for any particular purpose, nor does DACO Semiconductor assume any liability arising out of the application or use of any product or circuit, and specifically disclaims any liability, including without limitation special, consequential or incidental damages.

Purchasers are responsible for its products and applications using DACO Semiconductor products, including compliance with all laws, regulations, and safety requirements or standards, regardless of any support or application information provided by DACO Semiconductor. "Typical" parameters that may be provided in DACO Semiconductor datasheets and/or specifications can and do vary in different applications and actual performance may vary over time. All operating parameters, including "Typical" must be validated for each customer application by the customer's technical experts.

DACO Semiconductor products are not designed, authorized, or warranted to be suitable for use in life support, life-critical or safety-critical systems, or equipment, nor in applications where failure or malfunction of DACO Semiconductor's product can reasonably be expected to result in personal injury, death or severe property or environmental damage. DACO Semiconductor accepts no liability for the inclusion and/or use of DACO Semiconductor's products in such equipment or applications and therefore such inclusion and/or use is at the customer's own risk.

Purchasers who buy or use DACO Semiconductor products for any unintended or unauthorized applications are required to indemnify and absolve DACO Semiconductor, its suppliers, and distributors from any claims, costs, damages, expenses, and reasonable attorney fees arising out of, directly or indirectly, any claim of personal injury or death associated with such unintended or unauthorized use, even if such claim alleges that DACO Semiconductor was negligent regarding the design or manufacture of the part.

No part of this publication may be reproduced or transmitted in any form or by any means, electronic or mechanical, including photocopying and recording, or by any information storage and retrieval system, or otherwise, without the prior written permission of DACO Semiconductor Co., Ltd.