

## Silicon Carbide Enhancement Mode MOSFET

### Features

- Low On-Resistance and High Current Capability
- Low Capacitance for High Speed Switching Operation
- Positive Temperature Coefficient Device
- Low Impedance Kelvin Source Pin-Out
- RoHS Compliant and Halogen Free

### Benefits

- Higher System Efficiency
- Ease of Paralleling
- Capable of 175°C High T<sub>J</sub> Application
- Capable of High Switching Frequency Operating
- Miniaturize and Light Weight System

### Applications

- Switching Mode Power Supply
- DC/DC Converters, UPS, and PFC
- EV Charging Station
- Motor Drives
- Power Inverters
- Solar/Wind Renewable Energy

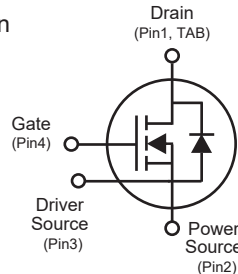

$V_{DSS}$	1200V
$I_{D(@25^{\circ}C)}$	62A
$R_{DS(ON)}$	40m $\Omega$

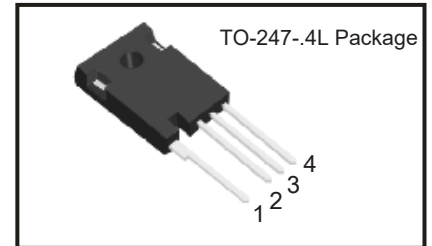

Package Dimensions

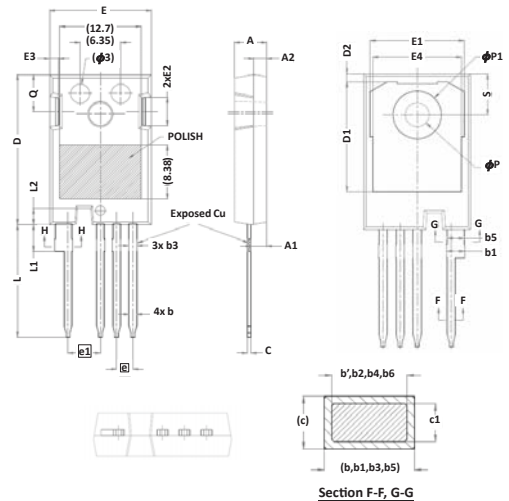

### Absolute Maximum Ratings

(T<sub>c</sub> = 25°C unless otherwise specified)

Parameter	Symbol	Ratings	Unit
Drain-Source Voltage	$V_{DS}$	1200	V
Gate-Source Voltage	$V_{GS}$	-5/+20	V
Drain Current-Continuous @ T <sub>c</sub> = 25°C @ T <sub>c</sub> = 110°C	$I_D$	62 42	A
Pulse Drain Current	$I_{D,pulse}$	223	A
Power Dissipation	$P_D$	326	W
Avalanche Energy, Single Pulse $V_{DD}=100V$ $I_D=12A$	$E_{AS}$	1875	mJ
Storage Temperature Range	$T_{STG}$	-55 to +175	°C
Operating Junction Temperature Range	$T_J$	-55 to +175	°C
Thermal Resistance, Junction-to-Case	$R_{\theta_{JC}}$	0.46	°C/W
Mounting Torque (M3 or 6-32 screw)	$M_d$	1.0	Nm

Symbol	mm		
	Min.	Typ.	Max.
A	4.83	5.02	5.21
A1	2.29	2.41	2.54
A2	1.91	2.00	2.16
b'	1.07	1.20	1.28
b	1.07	1.20	1.33
b1	2.39	2.67	2.94
b2	2.39	2.67	2.84
b3	1.07	1.30	1.60
b4	1.07	1.30	1.50
b5	2.39	2.53	2.69
b6	2.39	2.53	2.64
c	0.55	0.60	0.68
c1	0.55	0.60	0.65
D	23.30	23.45	23.60
D1	16.25	16.55	17.65
D2	0.95	1.19	1.25
E	15.75	15.94	16.13
E1	13.10	14.02	14.15
E2	3.68	4.40	5.10
E3	1.00	1.45	1.90
E4	12.38	13.26	13.43
e	2.54 BSC		
e1	5.08 BSC		
L	17.31	17.57	17.82
L1	3.97	4.19	4.37
L2	2.35	2.50	2.65
$\phi P$	3.51	3.61	3.65
$\phi P1$	7.19 REF.		
Q	5.49	5.79	6.00
S	6.04	6.17	6.30

**Electrical Characteristics @  $T_c = 25^\circ\text{C}$  (unless otherwise specified)**

Parameter	Symbol	Conditions	Min.	Typ.	Max.	Unit
<b>OFF Characteristics</b>						
Drain-Source Breakdown Voltage	$BV_{DSS}$	$V_{GS}=0V, I_{DS}=0.1mA$	1200	-	-	V
Zero Gate Voltage Drain Current	$I_{DSS}$	$V_{GS}=0V, V_{DS}=1200V$	-	<1	50	$\mu A$
Gate-Source Leakage Current	$I_{GSS}$	$V_{GS}=20V, V_{DS}=0V$	-	-	250	nA
<b>ON Characteristics</b>						
Gate Threshold Voltage	$V_{GS(th)}$	$V_{DS}=10V, I_{DS}=40mA$	1.5	2.7	-	V
Drain-Source On-State Resistance	$R_{DS(on)}$	$V_{GS}=20V, I_{DS}=30A$	-	40	52	m $\Omega$
Internal Gate Resistance	$R_{G(int.)}$	$f=1MHz, V_{AC}=25mV$	-	0.9	-	$\Omega$
<b>Dynamic Characteristics</b>						
Input Capacitance	$C_{iss}$	$V_{DS}=800V$	-	3619	-	pF
Output Capacitance	$C_{oss}$	$V_{GS}=0V$ $V_{AC}=25mV$	-	145	-	
Reverse Transfer Capacitance	$C_{rss}$	Freq.=1MHz	-	18	-	
$C_{oss}$ Stored Energy	$E_{oss}$	$V_{GS}=0V, V_{DS}=800V$ Freq.=1MHz, $V_{AC}=25mV$	-	59	-	$\mu J$
Turn-On Switching Energy	$E_{on}$	$V_{DD}=800V$ $V_{GS}=0V/+20V, I_D=30A$	-	83*	-	
Turn-Off Switching Energy	$E_{off}$	$R_{G(ext)}=2.7\Omega$	-	128*	-	
<b>Switching Characteristics</b>						
Turn-On Delay Time	$t_{d(on)}$	$V_{DS}=800V$	-	26	-	ns
Rise Time	$t_r$	$V_{GS}=-4/+20V$	-	50	-	
Turn-Off Delay Time	$t_{d(off)}$	$I_D=30A, R_L=27\Omega$	-	7	-	
Fall Time	$t_f$	$R_{G(ext)}=2.7\Omega$	-	11	-	
Total Gate Charge	$Q_g$	$V_{DS}=800V$	-	229	-	nC
Gate to Source Charge	$Q_{gs}$	$V_{GS}=-5/+20V$	-	68	-	
Gate to Drain Charge	$Q_{gd}$	$I_D=30A$	-	66	-	
<b>Body Diode Characteristics</b>						
Inverse Diode Forward Voltage	$V_{SD}$	$V_{GS}=0V, I_{SD}=7.5A$	-	2.9	-	V
Continuous Diode Forward Current	$I_S$	$V_{GS}=0V, T_c=25^\circ C$	-	48	-	A
Reverse Recovery Time	$T_{rr}$	$V_{GS}=0V$	-	59	-	ns
Reverse Recovery Charge	$Q_{rr}$	$I_{SD}=30A, V_{DS}=400V,$ $di/dt=300A/\mu s$	-	212	-	nC
Peak Reverse Recovery Current	$I_{rrm}$		-	5.1	-	A

\*Based on the results of calculation, note that the energy loss caused by the reverse recovery of free-wheeling diode is not included in Eon.

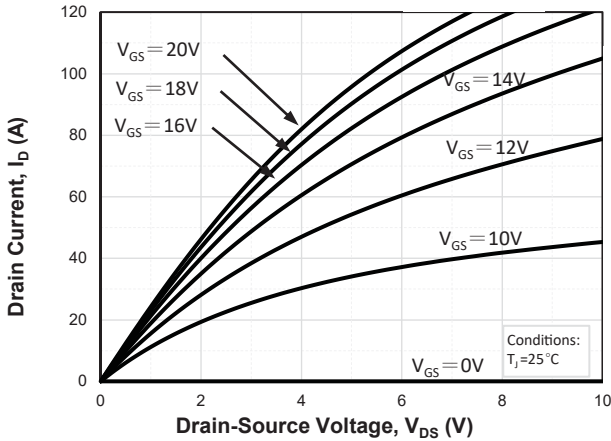
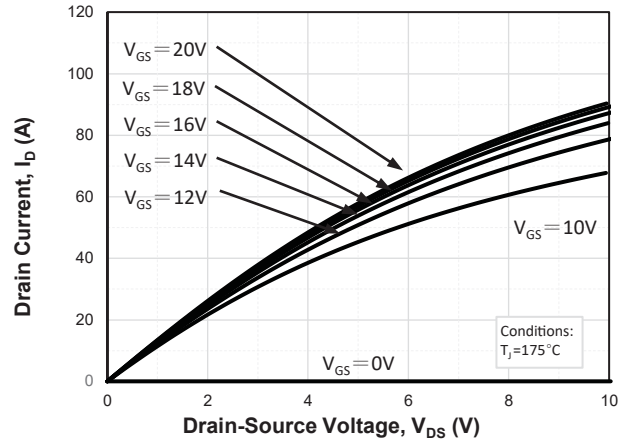
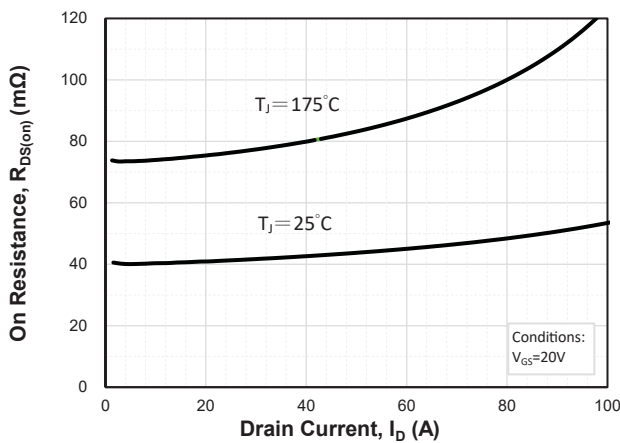
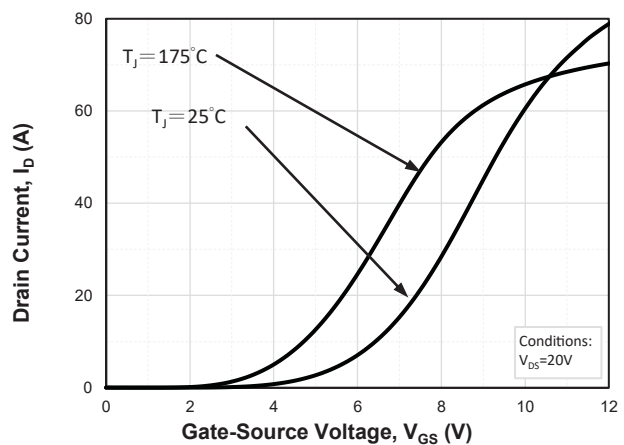
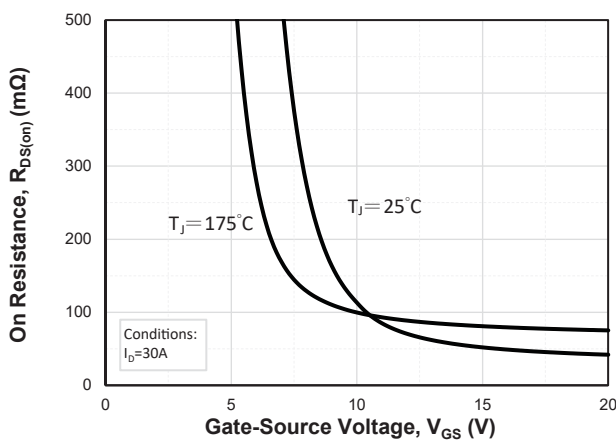
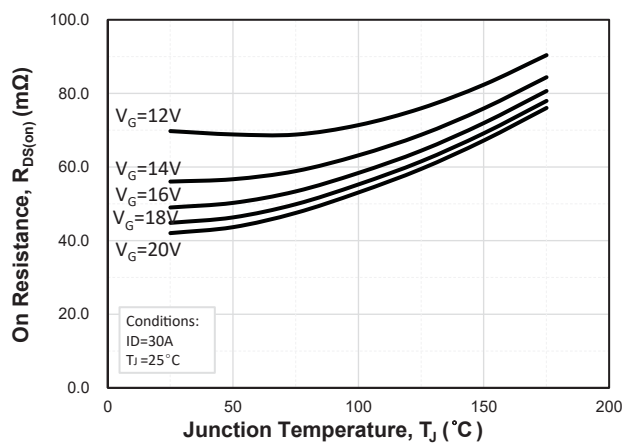
**Typical Device Performance**
**Fig.1 Forward Output Characteristics at  $T_J=25^\circ\text{C}$** 

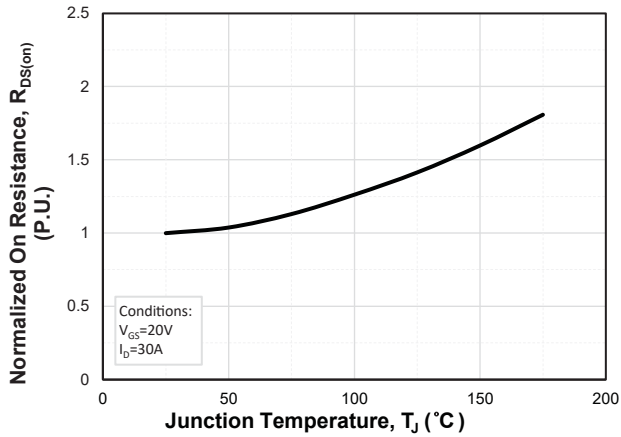
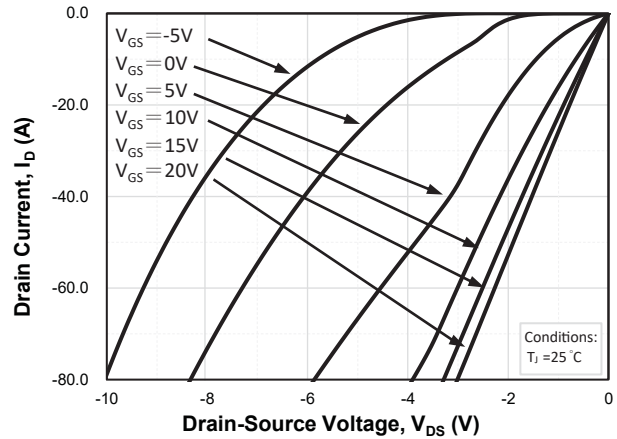
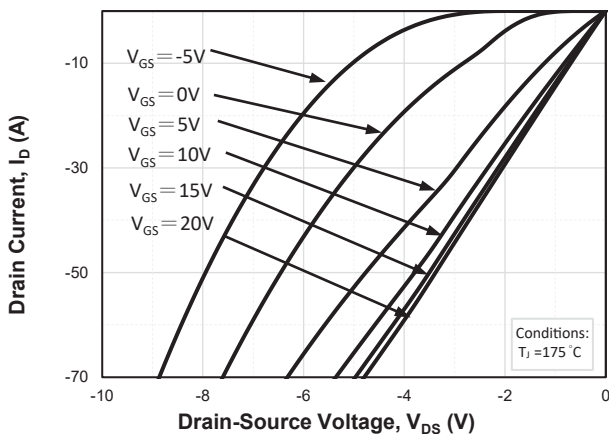
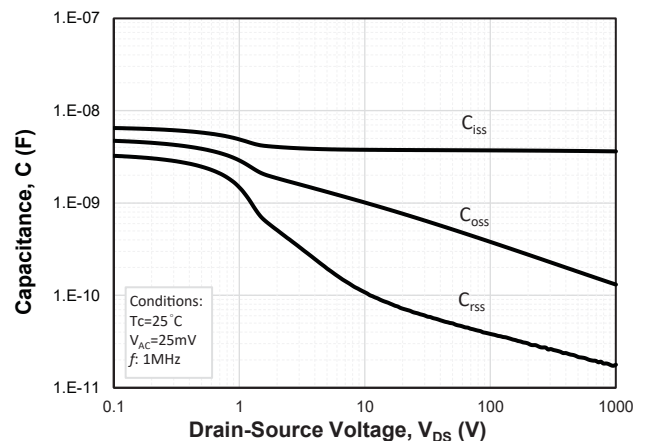
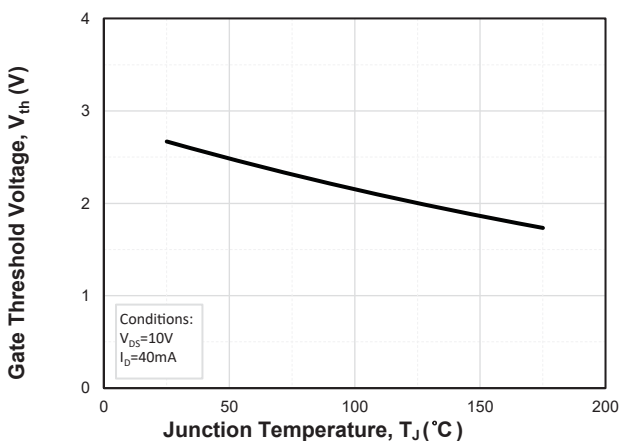
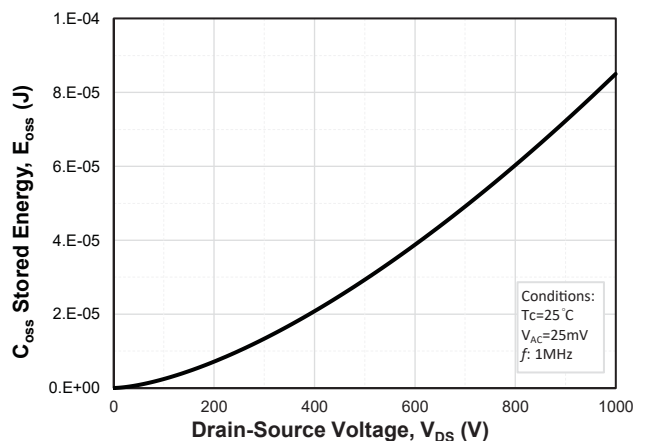
**Fig.2 Forward Output Characteristics at  $T_J=175^\circ\text{C}$** 

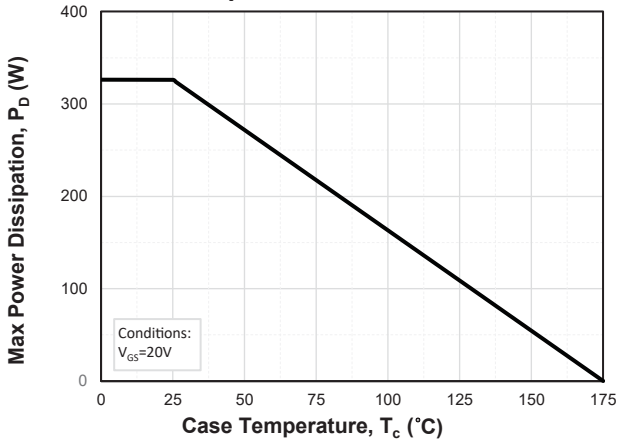
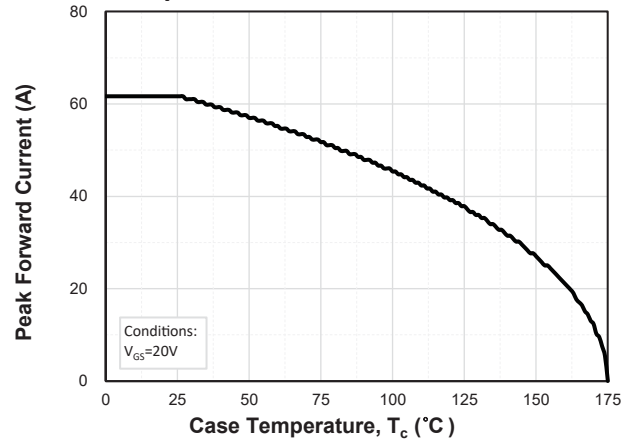
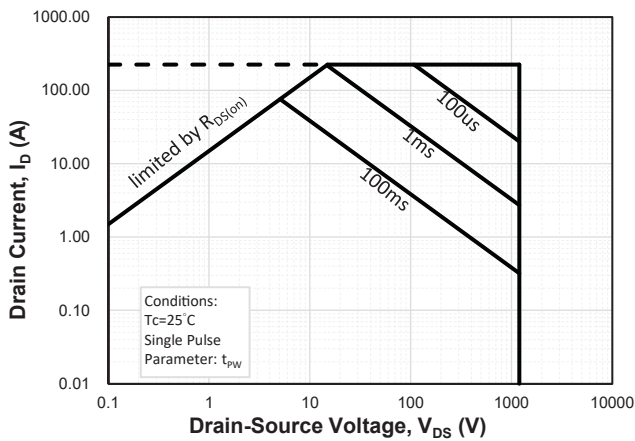
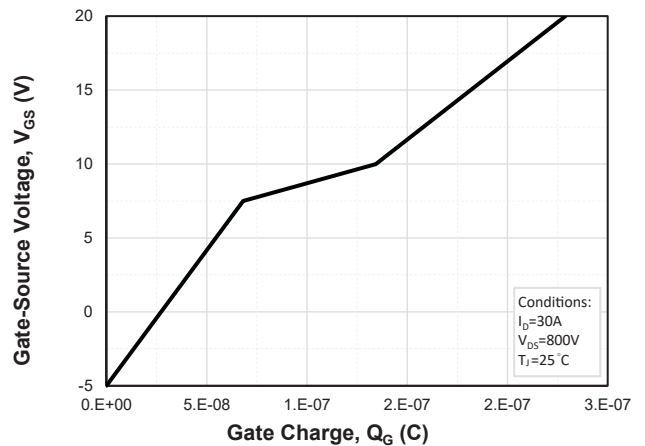
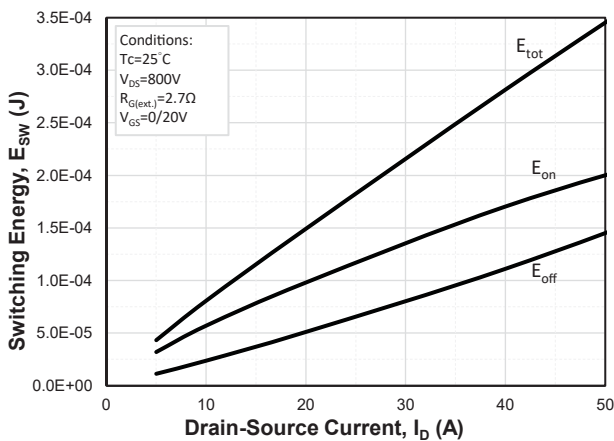
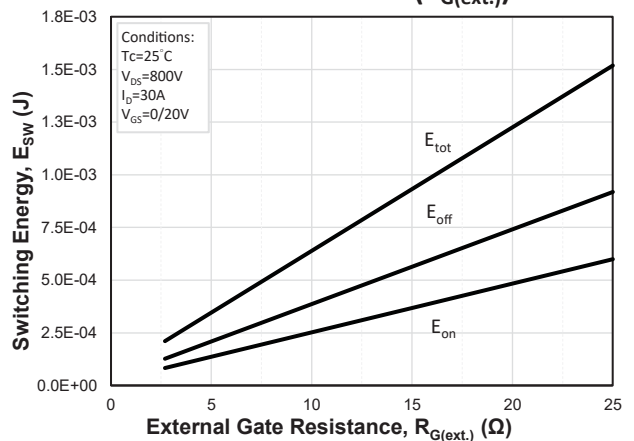
**Fig.3 On-Resistance vs. Drain Current for Various  $T_J$** 

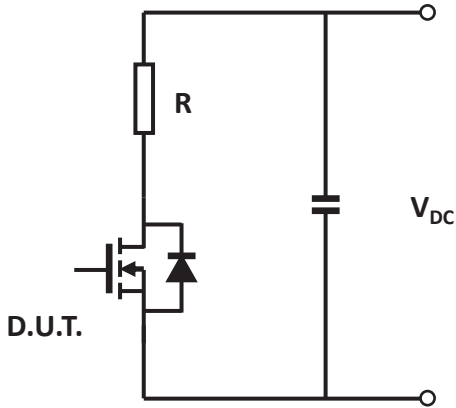
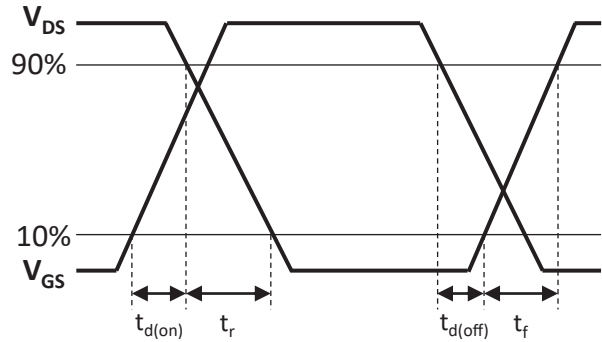
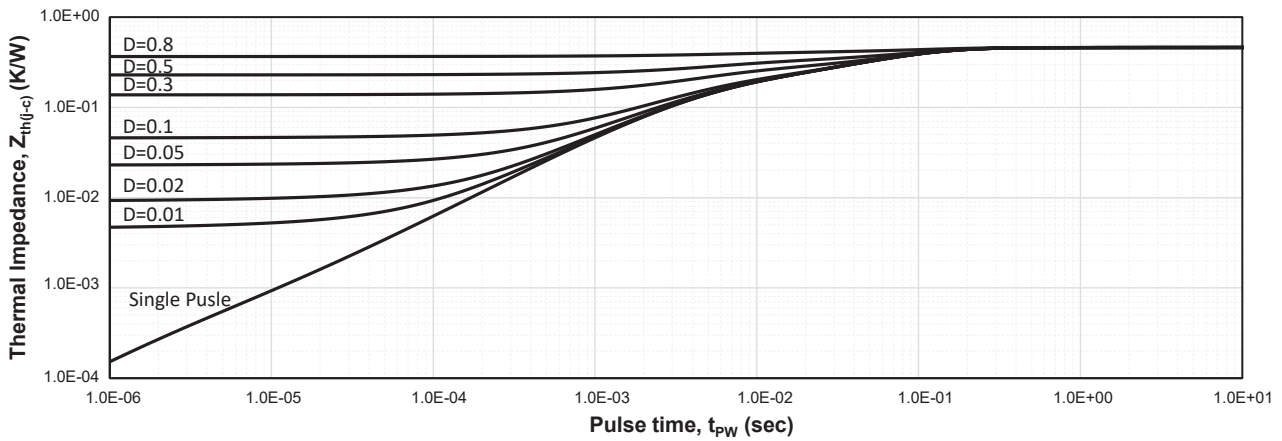
**Fig.4 Transfer Characteristics for Various  $T_J$** 

**Fig.5 On-Resistance vs. Gate Voltage for Various  $T_J$** 

**Fig.6 On-Resistance vs. Temperature for Various Gate Voltage**

**Typical Device Performance**
**Fig.7 Normalized On-Resistance vs. Temperature**

**Fig.8 Reverse Output Characteristics at  $T_J = 25^\circ\text{C}$** 

**Fig.9 Reverse Output Characteristics at  $T_J = 175^\circ\text{C}$** 

**Fig.10 Capacitances vs. Drain to Source Voltage**

**Fig.11 Threshold Voltage vs. Temperature**

**Fig.12 Output Capacitor Stored Energy**

**Typical Device Performance**
**Fig.13 Maximum Power Dissipation Derating vs. Case Temperature**

**Fig.14 Drain Current Derating vs. Case Temperature**

**Fig.15 Safe Operating Area**

**Fig.16 Gate Charge Characteristics**

**Fig.17 Clamped Inductive Switching Energy vs. Drain Current**

**Fig.18 Clamped Inductive Switching Energy vs. External Gate Resistor (R<sub>G(ext.)</sub>)**

**Typical Device Performance**
**Fig.19 Schematic of Resistive Switching**

**Fig.20 Switching Times Definition**

**Fig.21 Transient Junction to Case Thermal Impedance**

## Disclaimer

DACO Semiconductor reserves the right to make modifications, enhancements, improvements, corrections, or other changes to this document and any product described herein without prior notice. For the most up-to-date version, please visit our website.

DACO Semiconductor makes no warranty, representation, or guarantee regarding the suitability of its products for any particular purpose, nor does DACO Semiconductor assume any liability arising out of the application or use of any product or circuit, and specifically disclaims any liability, including without limitation special, consequential or incidental damages.

Purchasers are responsible for its products and applications using DACO Semiconductor products, including compliance with all laws, regulations, and safety requirements or standards, regardless of any support or application information provided by DACO Semiconductor. "Typical" parameters that may be provided in DACO Semiconductor datasheets and/or specifications can and do vary in different applications and actual performance may vary over time. All operating parameters, including "Typical" must be validated for each customer application by the customer's technical experts.

DACO Semiconductor products are not designed, authorized, or warranted to be suitable for use in life support, life-critical or safety-critical systems, or equipment, nor in applications where failure or malfunction of DACO Semiconductor's product can reasonably be expected to result in personal injury, death or severe property or environmental damage. DACO Semiconductor accepts no liability for the inclusion and/or use of DACO Semiconductor's products in such equipment or applications and therefore such inclusion and/or use is at the customer's own risk.

Purchasers who buy or use DACO Semiconductor products for any unintended or unauthorized applications are required to indemnify and absolve DACO Semiconductor, its suppliers, and distributors from any claims, costs, damages, expenses, and reasonable attorney fees arising out of, directly or indirectly, any claim of personal injury or death associated with such unintended or unauthorized use, even if such claim alleges that DACO Semiconductor was negligent regarding the design or manufacture of the part.

No part of this publication may be reproduced or transmitted in any form or by any means, electronic or mechanical, including photocopying and recording, or by any information storage and retrieval system, or otherwise, without the prior written permission of DACO Semiconductor Co., Ltd.