



Silicon Carbide Enhancement Mode MOSFET

Features

- Low On-Resistance and High Current Capability
- Low Capacitance for High Speed Switching Operation
- Positive Temperature Coefficient Device
- Low Impedance Kelvin Source Pin-Out
- RoHS Compliant and Halogen Free

Benefits

- Higher System Efficiency
- Ease of Paralleling
- Capable of 175°C High T_J Application
- Capable of High Switching Frequency Operating
- Miniaturize and Light Weight System

Applications

- Switching Mode Power Supply
- DC/DC Converters, UPS, and PFC
- EV Charging Station
- Motor Drives
- Power Inverters
- Solar/Wind Renewable Energy

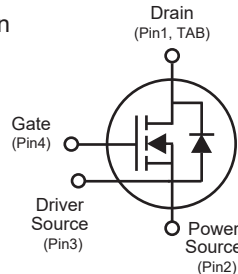

V _{DSS}	1200V
I _D (@25°C)	62A
R _{DS(ON)}	40mΩ

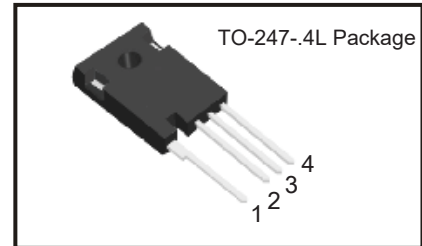

Package Dimensions

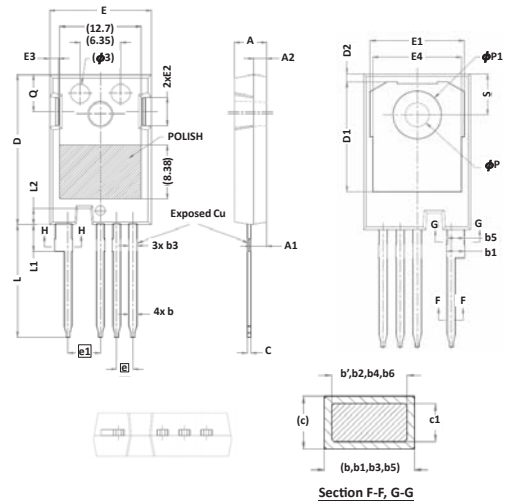

Absolute Maximum Ratings

(T_c = 25°C unless otherwise specified)

Parameter	Symbol	Ratings	Unit
Drain-Source Voltage	V _{DS}	1200	V
Gate-Source Voltage	V _{GS}	-5/+20	V
Drain Current-Continuous @ T _c =25°C @ T _c =110°C	I _D	62 42	A
Pulse Drain Current	I _{D,pulse}	223	A
Power Dissipation	P _D	326	W
Avalanche Energy, Single Pulse V _{DD} =100V I _D =12A	E _{AS}	1875	mJ
Storage Temperature Range	T _{STG}	-55 to +175	°C
Operating Junction Temperature Range	T _J	-55 to +175	°C
Thermal Resistance, Junction-to-Case	R _{θJC}	0.46	°C/W
Mounting Torque (M3 or 6-32 screw)	M _d	1.0	Nm

Symbol	mm		
	Min.	Typ.	Max.
A	4.83	5.02	5.21
A1	2.29	2.41	2.54
A2	1.91	2.00	2.16
b'	1.07	1.20	1.28
b	1.07	1.20	1.33
b1	2.39	2.67	2.94
b2	2.39	2.67	2.84
b3	1.07	1.30	1.60
b4	1.07	1.30	1.50
b5	2.39	2.53	2.69
b6	2.39	2.53	2.64
c	0.55	0.60	0.68
c1	0.55	0.60	0.65
D	23.30	23.45	23.60
D1	16.25	16.55	17.65
D2	0.95	1.19	1.25
E	15.75	15.94	16.13
E1	13.10	14.02	14.15
E2	3.68	4.40	5.10
E3	1.00	1.45	1.90
E4	12.38	13.26	13.43
e	2.54 BSC		
e1	5.08 BSC		
L	17.31	17.57	17.82
L1	3.97	4.19	4.37
L2	2.35	2.50	2.65
φP	3.51	3.61	3.65
φP1	7.19 REF.		
Q	5.49	5.79	6.00
S	6.04	6.17	6.30



Electrical Characteristics @ T_c =25°C (unless otherwise specified)

Parameter	Symbol	Conditions	Min.	Typ.	Max.	Unit
OFF Characteristics						
Drain-Source Breakdown Voltage	BV_{DSS}	$V_{GS}=0V, I_{DS}=0.1mA$	1200	-	-	V
Zero Gate Voltage Drain Current	I_{DSS}	$V_{GS}=0V, V_{DS}=1200V$	-	<1	50	μA
Gate-Source Leakage Current	I_{GSS}	$V_{GS}=20V, V_{DS}=0V$	-	-	250	nA
ON Characteristics						
Gate Threshold Voltage	$V_{GS(th)}$	$V_{DS}=10V, I_{DS}=40mA$	1.5	2.7	-	V
Drain-Source On-State Resistance	$R_{DS(on)}$	$V_{GS}=20V, I_{DS}=30A$	-	40	52	mΩ
Internal Gate Resistance	$R_{G(int.)}$	$f=1MHz, V_{AC}=25mV$	-	0.9	-	Ω
Dynamic Characteristics						
Input Capacitance	C_{iss}	$V_{DS}=800V$ $V_{GS}=0V$	-	3619	-	pF
Output Capacitance	C_{oss}	$V_{AC}=25mV$	-	145	-	
Reverse Transfer Capacitance	C_{rss}	Freq.=1MHz	-	18	-	
C _{oss} Stored Energy	E_{oss}	$V_{GS}=0V, V_{DS}=800V$ Freq.=1MHz, $V_{AC}=25mV$	-	59	-	μJ
Turn-On Switching Energy	E_{on}	$V_{DD}=800V$ $V_{GS}=0V/+20V, I_D=30A$	-	83*	-	
Turn-Off Switching Energy	E_{off}	$R_{G(ext)}=2.7Ω$	-	128*	-	
Switching Characteristics						
Turn-On Delay Time	$t_{d(on)}$	$V_{DS}=800V$	-	26	-	ns
Rise Time	t_r	$V_{GS}=-4/+20V$	-	50	-	
Turn-Off Delay Time	$t_{d(off)}$	$I_D=30A, R_L=27Ω$	-	7	-	
Fall Time	t_f	$R_{G(ext)}=2.7Ω$	-	11	-	
Total Gate Charge	Q_g	$V_{DS}=800V$	-	229	-	nC
Gate to Source Charge	Q_{gs}	$V_{GS}=-5/+20V$	-	68	-	
Gate to Drain Charge	Q_{gd}	$I_D=30A$	-	66	-	
Body Diode Characteristics						
Inverse Diode Forward Voltage	V_{SD}	$V_{GS}=0V, I_{SD}=7.5A$	-	2.9	-	V
Continuous Diode Forward Current	I_S	$V_{GS}=0V, T_c=25°C$	-	48	-	A
Reverse Recovery Time	T_{rr}	$V_{GS}=0V$	-	59	-	ns
Reverse Recovery Charge	Q_{rr}	$I_{SD}=30A, V_{DS}=400V,$ $di/dt=300A/μs$	-	212	-	nC
Peak Reverse Recovery Current	I_{rrm}		-	5.1	-	A

*Based on the results of calculation, note that the energy loss caused by the reverse recovery of free-wheeling diode is not included in E_{on}.



Typical Device Performance

Fig.1 Forward Output Characteristics at $T_J=25^{\circ}\text{C}$

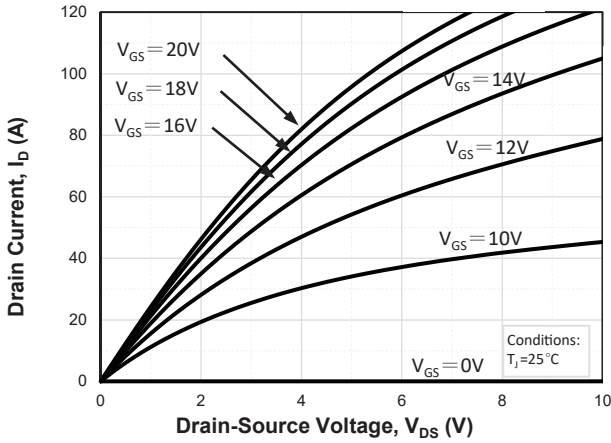

Fig.2 Forward Output Characteristics at $T_J=175^{\circ}\text{C}$

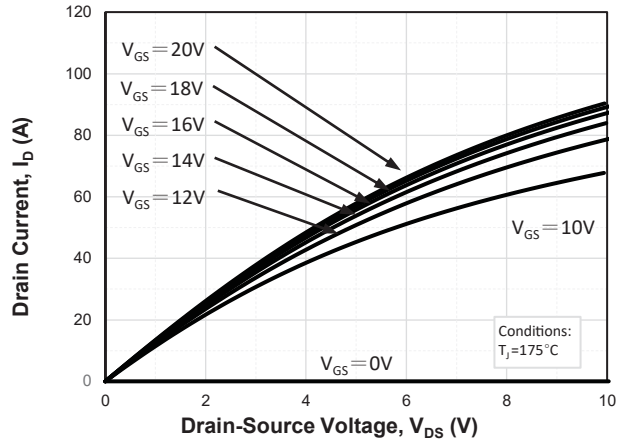

Fig.3 On-Resistance vs. Drain Current for Various T_J

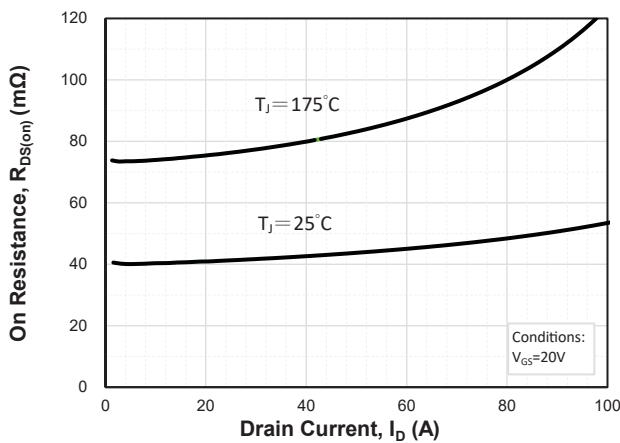

Fig.4 Transfer Characteristics for Various T_J

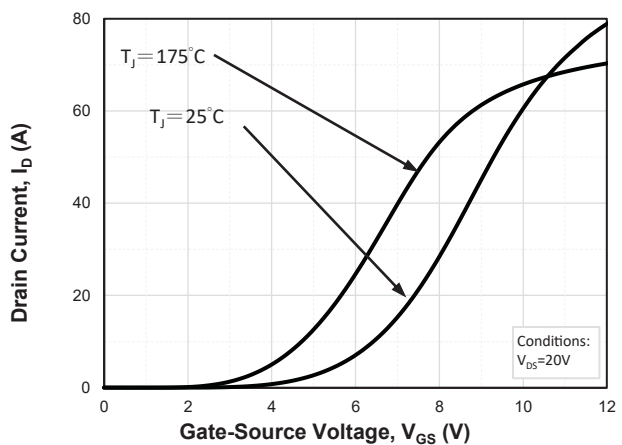

Fig.5 On-Resistance vs. Gate Voltage for Various T_J

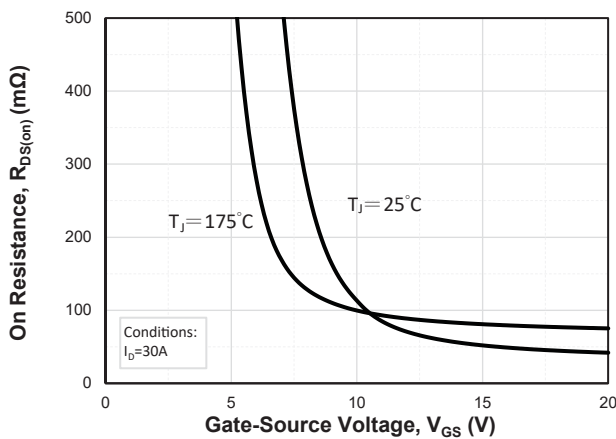
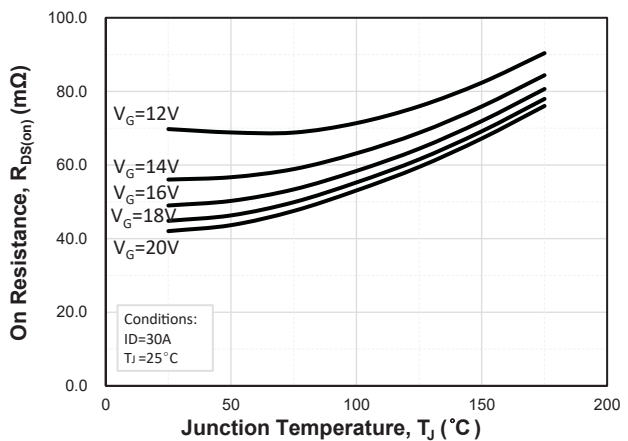

Fig.6 On-Resistance vs. Temperature for Various Gate Voltage





Typical Device Performance

Fig.7 Normalized On-Resistance vs. Temperature

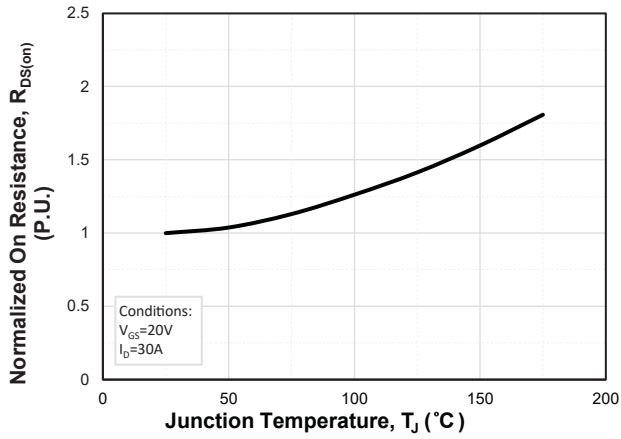

Fig.8 Reverse Output Characteristics at T_J = 25°C

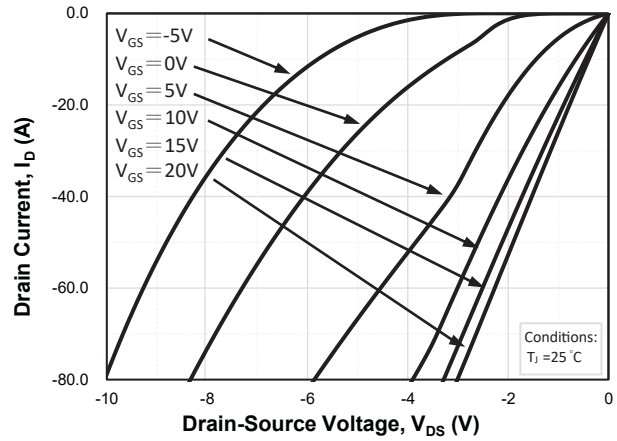

Fig.9 Reverse Output Characteristics at T_J = 175°C

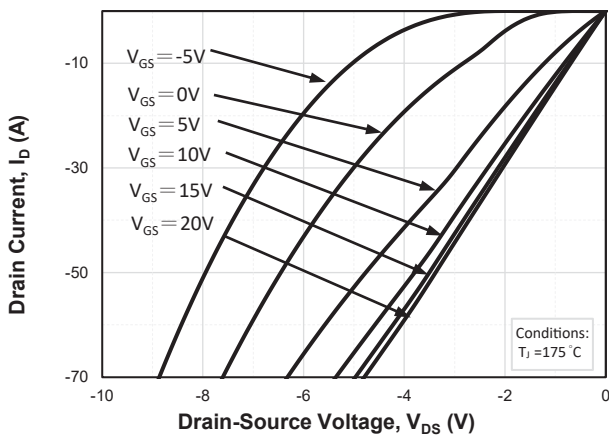

Fig.10 Capacitances vs. Drain to Source Voltage

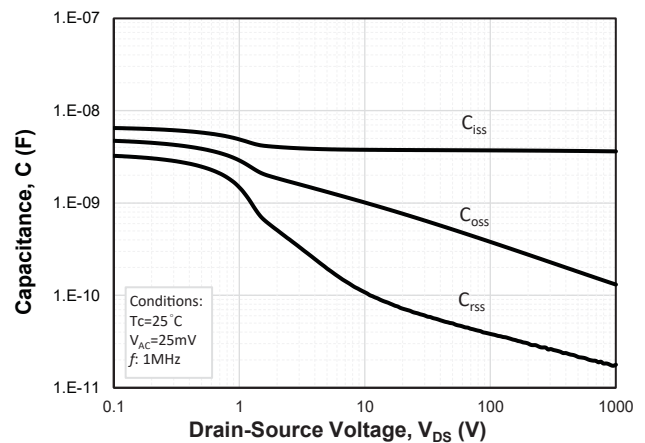

Fig.11 Threshold Voltage vs. Temperature

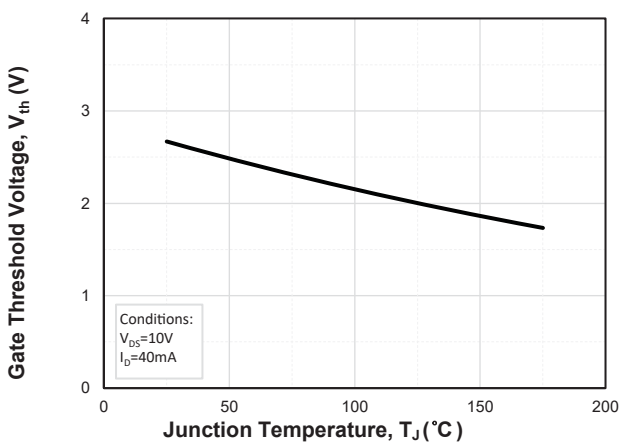
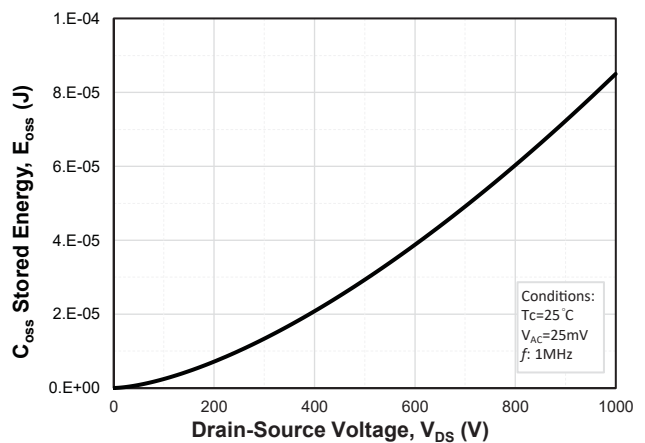

Fig.12 Output Capacitor Stored Energy





Typical Device Performance

Fig.13 Maximum Power Dissipation Derating vs. Case Temperature

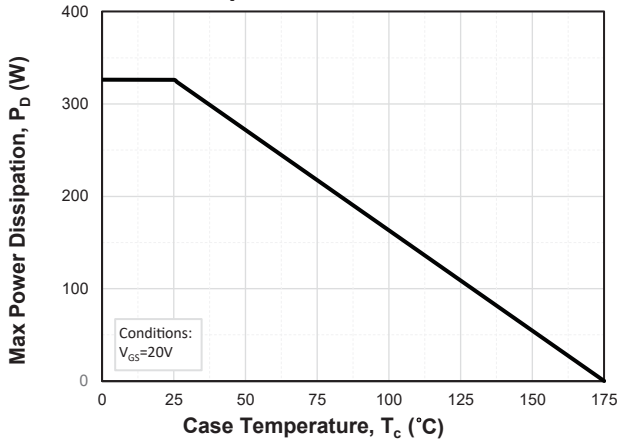

Fig.14 Drain Current Derating vs. Case Temperature

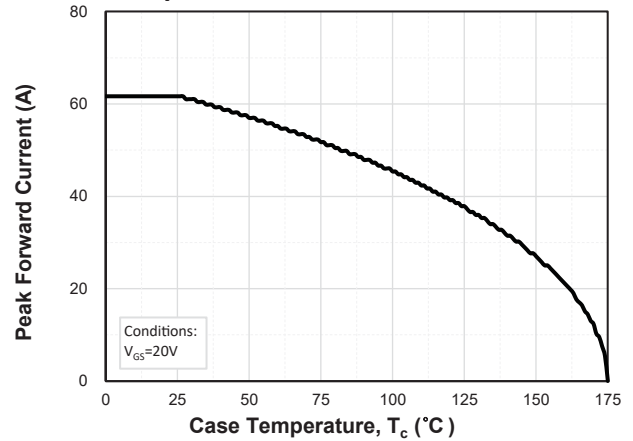

Fig.15 Safe Operating Area

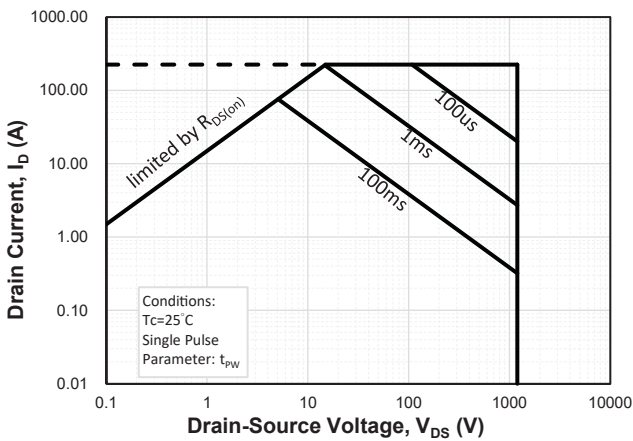

Fig.16 Gate Charge Characteristics

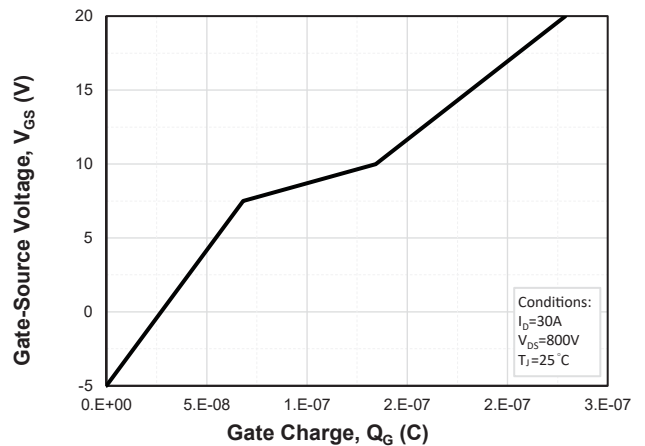

Fig.17 Clamped Inductive Switching Energy vs. Drain Current

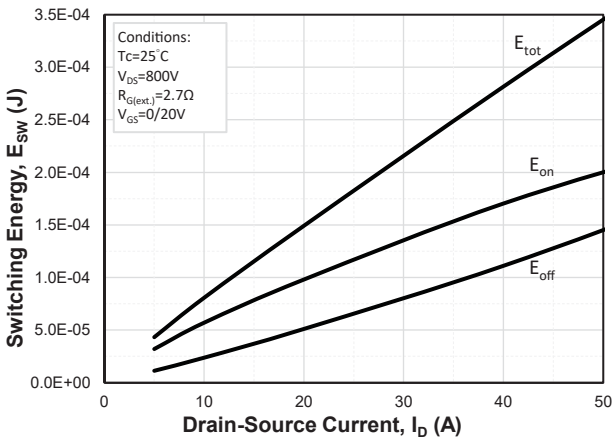
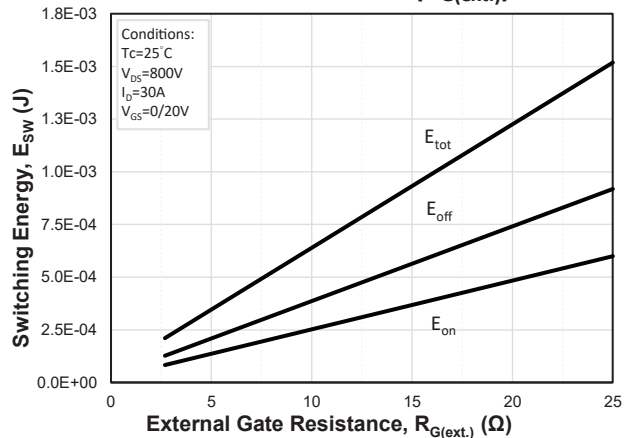

Fig.18 Clamped Inductive Switching Energy vs. External Gate Resistor (R_G(ext.))





Typical Device Performance

Fig.19 Schematic of Resistive Switching

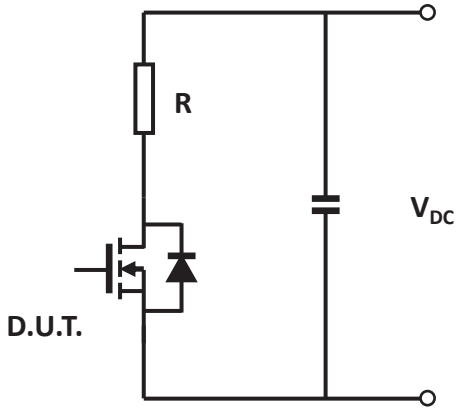

Fig.20 Switching Times Definition

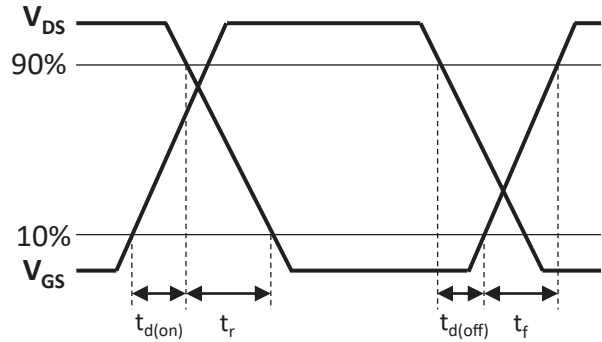
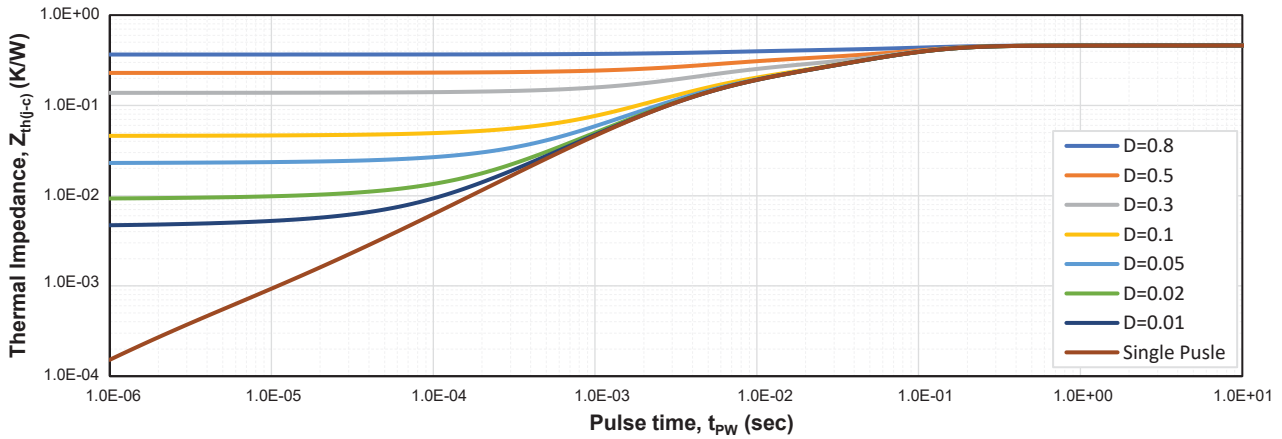

Fig.21 Transient Junction to Case Thermal Impedance





Disclaimer

DACO Semiconductor reserves the right to make modifications, enhancements, improvements, corrections, or other changes to this document and any product described herein without prior notice.

DACO Semiconductor makes no warranty, representation, or guarantee regarding the suitability of its products for any particular purpose, nor does DACO Semiconductor assume any liability arising out of the application or use of any product or circuit, and specifically disclaims any liability, including without limitation special, consequential or incidental damages.

Purchasers are responsible for its products and applications using DACO Semiconductor products, including compliance with all laws, regulations, and safety requirements or standards, regardless of any support or application information provided by DACO Semiconductor. "Typical" parameters that may be provided in DACO Semiconductor datasheets and/or specifications can and do vary in different applications and actual performance may vary over time. All operating parameters, including "Typical" must be validated for each customer application by the customer's technical experts.

DACO Semiconductor products are not designed, authorized, or warranted to be suitable for use in life support, life-critical or safety-critical systems, or equipment, nor in applications where failure or malfunction of DACO Semiconductor's product can reasonably be expected to result in personal injury, death or severe property or environmental damage. DACO Semiconductor accepts no liability for the inclusion and/or use of DACO Semiconductor's products in such equipment or applications and therefore such inclusion and/or use is at the customer's own risk.

Purchasers who buy or use DACO Semiconductor products for any unintended or unauthorized applications are required to indemnify and absolve DACO Semiconductor, its suppliers, and distributors from any claims, costs, damages, expenses, and reasonable attorney fees arising out of, directly or indirectly, any claim of personal injury or death associated with such unintended or unauthorized use, even if such claim alleges that DACO Semiconductor was negligent regarding the design or manufacture of the part.

No part of this publication may be reproduced or transmitted in any form or by any means, electronic or mechanical, including photocopying and recording, or by any information storage and retrieval system, or otherwise, without the prior written permission of DACO Semiconductor Co., Ltd.