

Silicon Carbide Enhancement Mode MOSFET

Features

- High blocking voltage with low Rds(on)
- High frequency operation with low Capacitance
- Simple to drive with -4V/+18V gate
- Robust body diode with low Qrr
- 100% Avalanche tested

Benefits

- Superior robustness and system reliability
- Higher system efficiency
- Easier paralleling without thermal runaway
- Capable of high temperature application
- Faster and more efficient switching

Applications

- Server power
- EV/HEV charging station
- Energy storage systems
- High performance DC-DC converters
- On-board charger
- Battery management systems

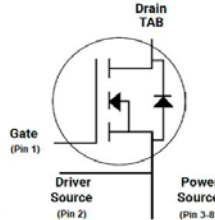

V_{DSS}	650V
$I_D(@25^{\circ}C)$	96A
$R_{DS(ON)}$ typ.	22.5m Ω

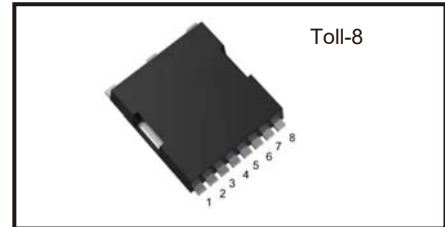

Package Dimensions

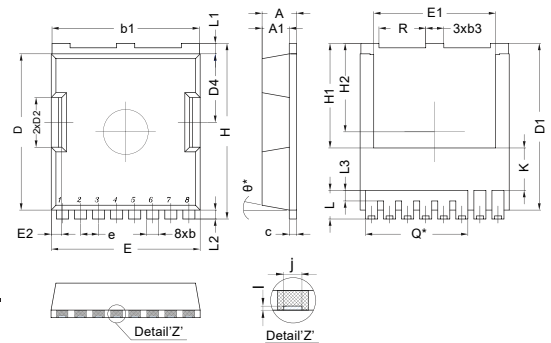

Absolute Maximum Ratings

(Tc = 25°C unless otherwise specified)

Parameter	Symbol	Ratings	Unit
Drain-Source Voltage $V_{GS}=0V$ $I_D=100\mu A$	V_{DS}	650	V
Gate-Source Voltage (dynamic) AC (f>1 Hz, duty cycle<1%, pulse width<200ns)	V_{GS}	-9/+23	V
Gate-Source Voltage (static)	$V_{GS(op)}$	-4/+18	V
Drain Current-Continuous @ Tc = 25°C @ Tc = 100°C	I_D	96 66	A
Pulse Drain Current	$I_{D,pulse}$	220	A
Power Dissipation	P_D	325	W
Storage Temperature Range	T_{STG}	-55 to +175	°C
Operating Junction Temperature Range	T_J	-55 to +175	°C
Soldering Temperature	T_L	260	°C
Avalanche Capability, single pulse * $V_{DD}=100V$ $V_{GS}=10V$ $L=2mH$	I_{AV}	36	A
Avalanche Capability, single pulse** $V_{DD}=100V$ $V_{GS}=10V$ $L=2mH$	E_{AV}	1200	mJ

* 100% tested in 60% rating

** 100% tested in 36% rating

SYMBOL	DIMENSIONS		
	MIN.	NOM.	MAX.
A	2.20	2.30	2.40
A1	1.70	1.80	1.90
b	0.70	0.80	0.90
b1	9.70	9.80	9.90
b3	1.10	1.20	1.30
c	0.40	0.50	0.60
D	10.28	10.38	10.48
D1	10.98	11.08	11.18
D2	3.20	3.30	3.40
D4	4.45	4.55	4.65
E	9.80	9.90	10.00
E1	8.00	8.10	8.20
E2	0.60	0.70	0.80
e	1.20 BSC		
H	11.58	11.68	11.78
H1	6.95 BSC		
H2	5.89 BSC		
I	0.10 REF.		
j	0.46 REF.		
K	2.80 REF.		
L	1.40	1.90	2.10
L1	0.60	0.70	0.80
L2	0.50	0.60	0.70
L3	0.30	0.70	0.80
N	8		
Q	6.80 REF.		
R	3.00	3.10	3.20
θ	10° REF.		

NOTE:

1. REFER TO JEDEC MO-299B.

2. ALL DIMENSIONS ARE IN MM, ANGLES IN DEGREES.

3. DIMENSIONS DO NOT INCLUSIVE BURRS AND MOLD FLASH.

4. *** IS FOR REFERENCE.

Electrical Characteristics @ T_c =25°C (unless otherwise specified)

Parameter	Symbol	Conditions	Min.	Typ.	Max.	Unit
OFF Characteristics						
Drain-Source Breakdown Voltage	BV _{DSS}	V _{GS} =0V, I _D =0.1mA	650	-	-	V
Zero Gate Voltage Drain Current	I _{DSS}	V _{DS} =650V, V _{GS} =0V	-	0.5	60	μA
		V _{DS} =650V, V _{GS} =0V, T _J =175°C	-	5	200	
Gate-Source Leakage Current	I _{GSS}	V _{GS} =18V, V _{DS} =0V	-	5	100	nA
		V _{GS} =-4V, V _{DS} =0V	-100	-5	-	
ON Characteristics						
Gate Threshold Voltage **	V _{GS(th)}	V _{DS} =V _{GS} , I _D =10mA	2.6	3.1	4.2	V
		V _{DS} =V _{GS} , I _D =10mA, T _J =150°C	-	2.2	-	
		V _{DS} =V _{GS} , I _D =10mA, T _J =175°C	-	2.1	-	
Drain-Source On-State Resistance	R _{DS(on)}	V _{GS} =18V, I _D =30A	-	22.5	28.5	mΩ
		V _{GS} =18V, I _D =30A, T _J =175°C	-	27	-	
Transconductance	g _{fs}	V _{DS} =20V, I _D =30A	-	23	-	S
		V _{DS} =20V, I _D =30A, T _J =175°C	-	21	-	
Internal Gate Resistance	R _{G(int.)}	f=1MHz, I _D =0A	-	1.2	-	Ω
Dynamic Characteristics						
Input Capacitance	C _{iss}	V _{DS} =400V V _{GS} =0V Freq.=1MHz V _{AC} =25mV	-	2400	-	pF
Output Capacitance	C _{oss}		-	190	-	
Reverse Transfer Capacitance	C _{rss}		-	8	-	
C _{oss} Stored Energy	E _{oss}		-	19	-	μJ
Turn-On Switching Energy	E _{on}	V _{DS} =400V, V _{GS} =-4/+18V I _D =30A, R _{G(ext)} =2.0Ω	-	29	-	μJ
Turn-Off Switching Energy	E _{off}	L=200μH	-	26	-	
Switching Characteristics						
Turn-On Delay Time	t _{d(on)}	V _{DS} =400V, V _{GS} =-4/+18V I _D =30A, R _{G(ext)} =2.0Ω L=200μH	-	15	-	ns
Rise Time	t _r		-	11	-	
Turn-Off Delay Time	t _{d(off)}		-	29	-	
Fall Time	t _f		-	6	-	
Total Gate Charge	Q _g	V _{DS} =400V V _{GS} =-4/+18V I _D =30A	-	112	-	nC
Gate to Source Charge	Q _{gs}		-	30	-	
Gate to Drain Charge	Q _{gd}		-	45	-	
Body Diode Characteristics						
Diode Forward Voltage	V _{SD}	V _{GS} =-4V, I _{SD} =20A, T _J =25°C	-	3.3	-	V
		V _{GS} =-4V, I _{SD} =20A, T _J =175°C	-	3.0	-	
Continuous Diode Forward Current	I _S	V _{GS} =-4V, T _J =25°C	-	62	-	A
Reverse Recovery Time	T _{rr}	I _{SD} =30A, V _{GS} =-4V V _R =400V, R _{G(ext)} =20Ω L=200μH, dif/dt=1420A/μs	-	22	-	ns
Reverse Recovery Charge	Q _{rr}		-	240	-	nC
Reverse Recovery Charge	I _{rrm}		-	21	-	A
Thermal Resistance						
Thermal Resistance, Junction-to-Case	R _{θJC}		-	0.46	0.55	°C/W

** Turn-off with -4V gate bias is highly recommended

Typical Performance

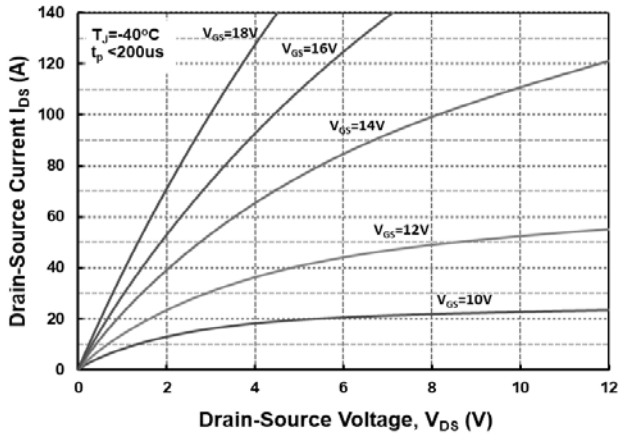
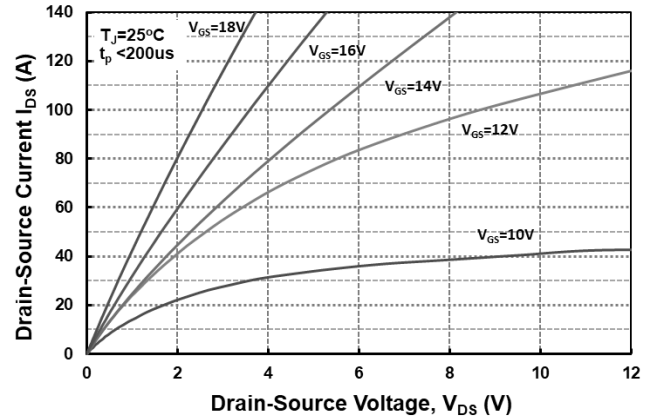
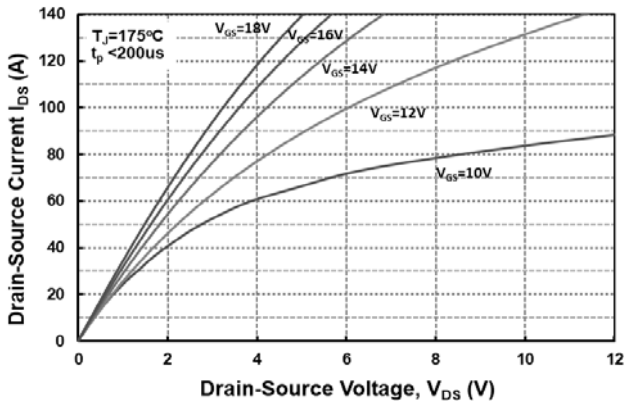
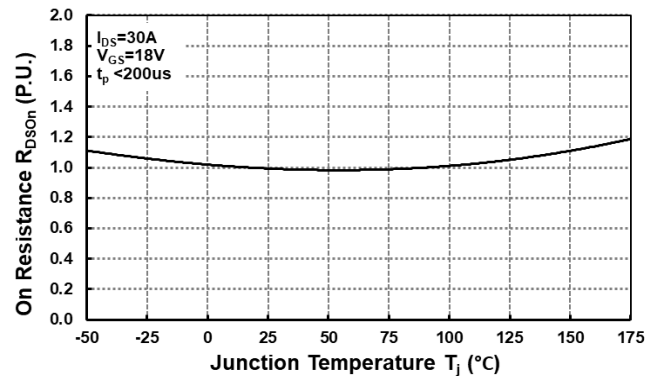
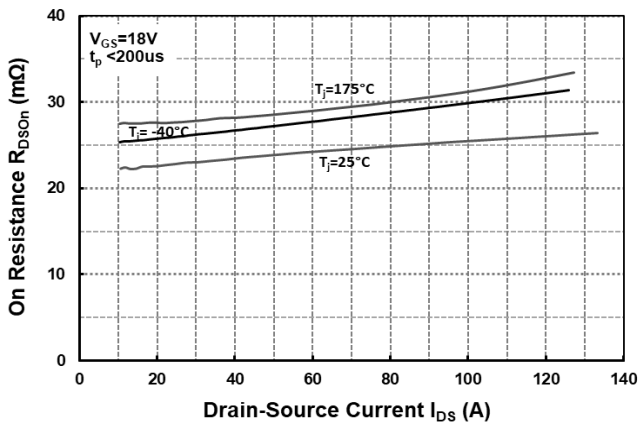
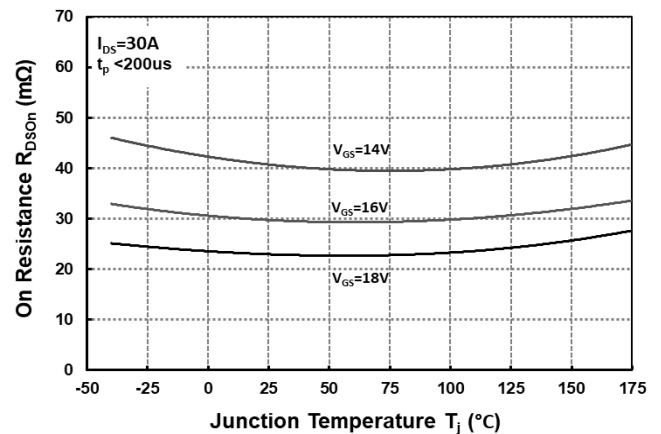
Fig 1. Output Characteristics, $T_J = -40^\circ\text{C}$

Fig 2. Output Characteristics, $T_J = 25^\circ\text{C}$

Fig 3. Output Characteristics at $T_J = 175^\circ\text{C}$

Fig 4. Normalized On-Resistance vs. Temperature

Fig 5. On-Resistance vs. Drain Current for Various Temperatures

Fig 6. On-Resistance vs. Temperature for Various Gate Voltage

Typical Performance

Fig 7. Transfer Characteristic for Various Junction Temperatures

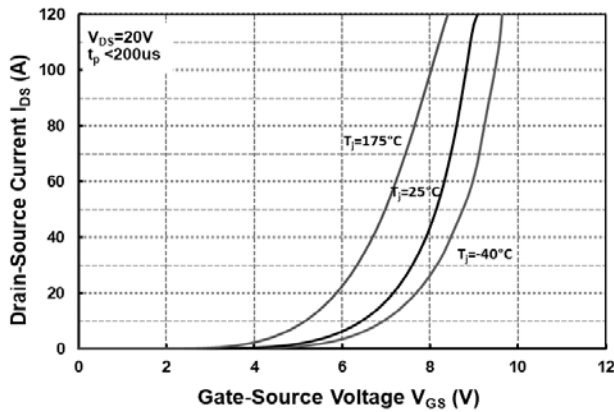

Fig 8. Body Diode Characteristics @ -40°C

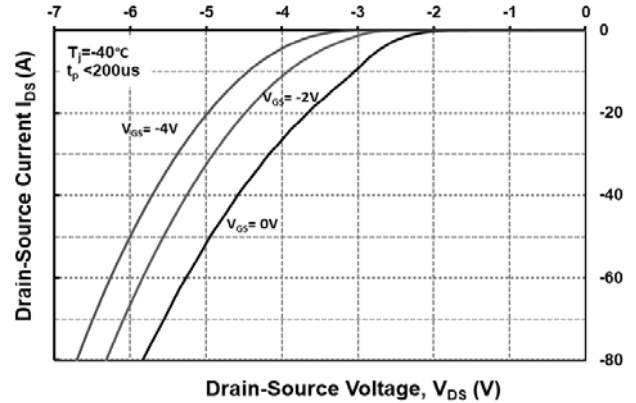

Fig 9. Body Diode Characteristics @ 25°C

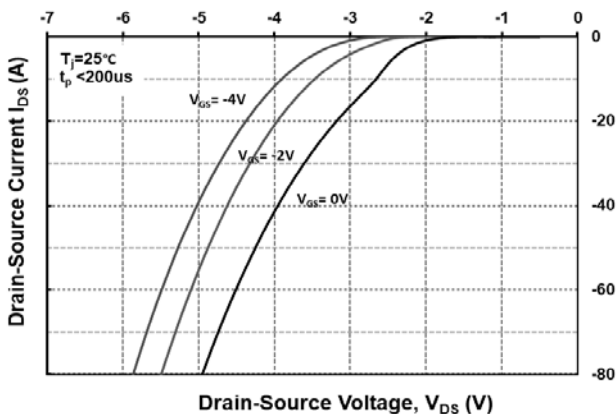

Fig 10. Body Diode Characteristics @ 175°C

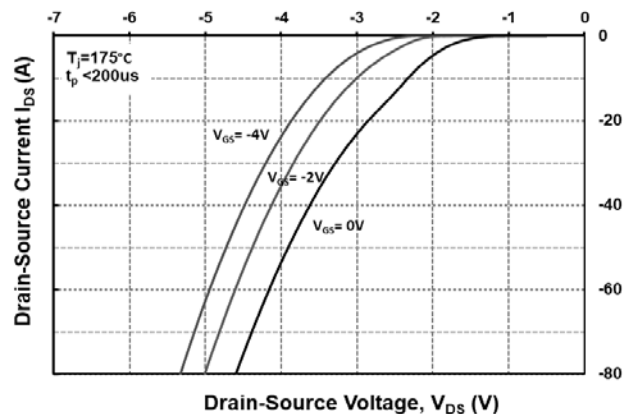

Fig 11. Threshold Voltage vs. Temperature

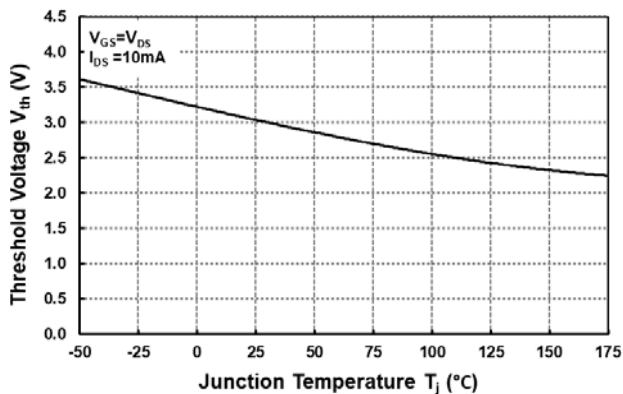
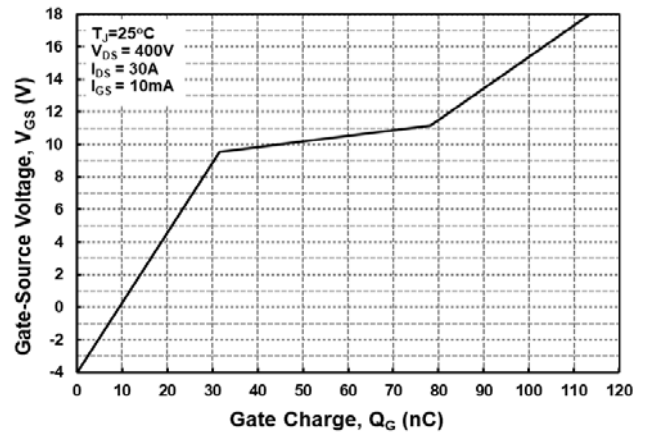
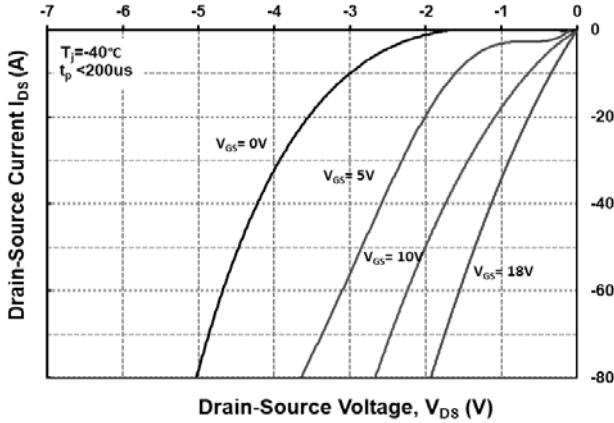
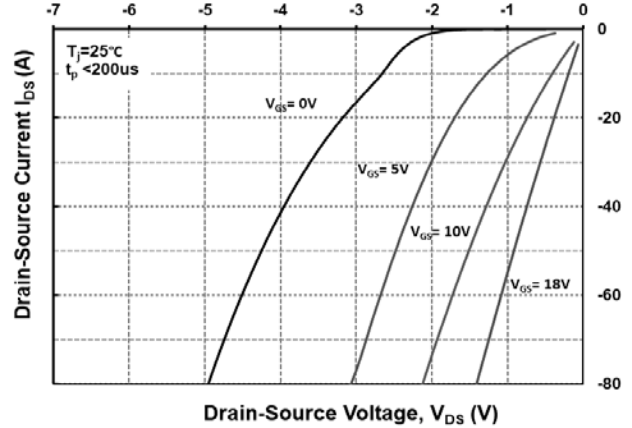
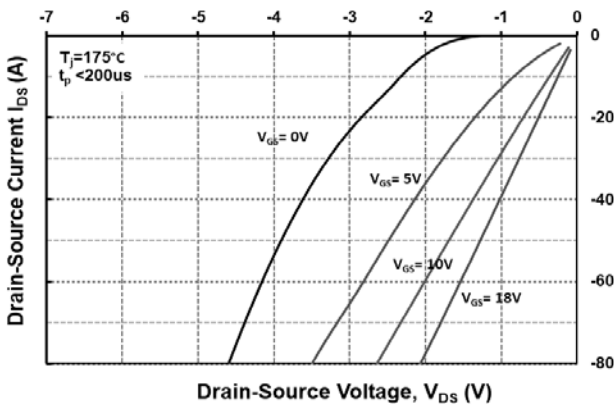
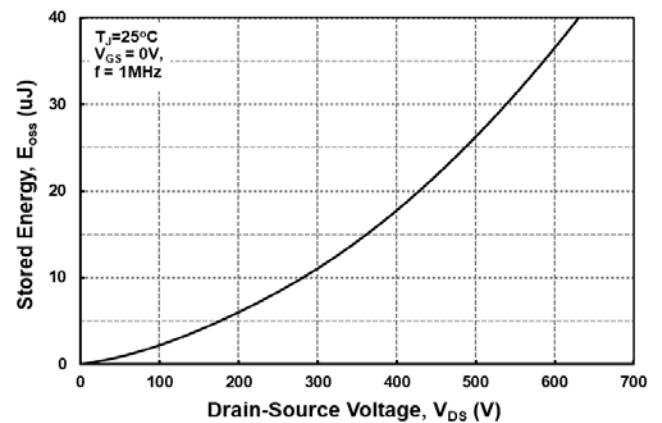
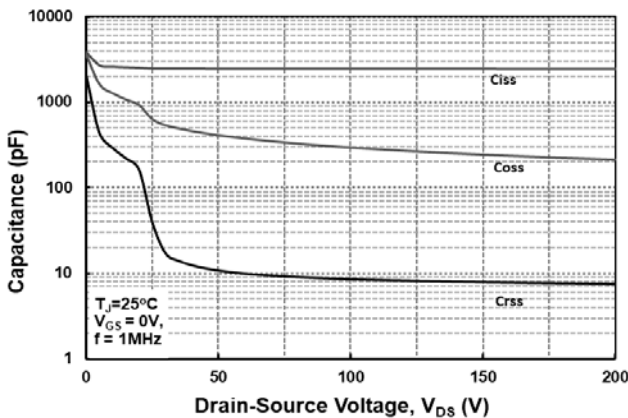
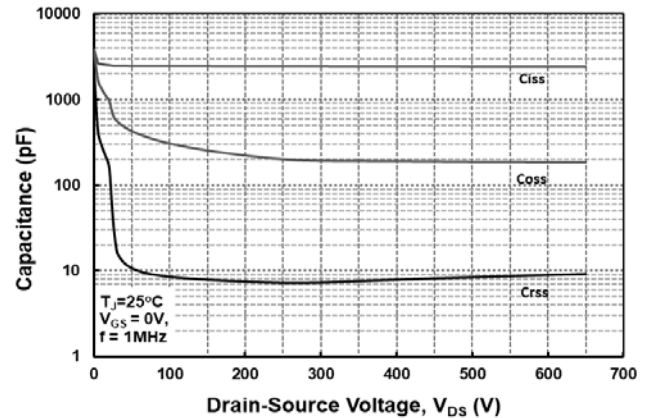

Fig 12. Gate Charge Characteristics



Typical Performance
Fig 13. 3rd Quadrant Characteristics @ -40°C

Fig 14. 3rd Quadrant Characteristics @ 25°C

Fig 15. 3rd Quadrant Characteristics @ 175°C

Fig 16. Output Capacitor Stored Energy

Fig 17. Capacitances vs. Drain-Source Voltage (0-200V)

Fig 18. Capacitances vs. Drain-Source Voltage (0-650V)

Typical Performance

Fig 19. Continuous Drain Current Derating vs. Case Temperature

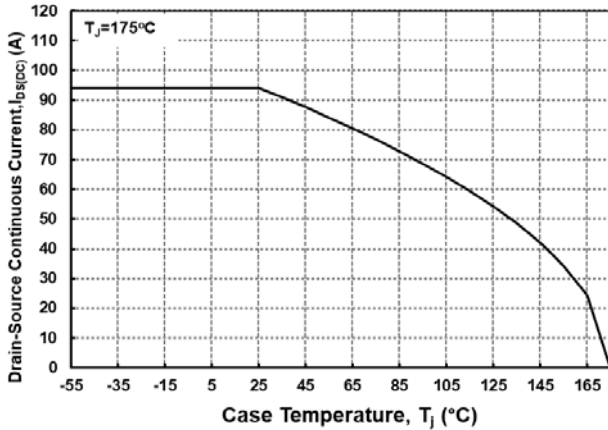

Fig 20. Maximum Power Dissipation Derating vs. Case Temperature

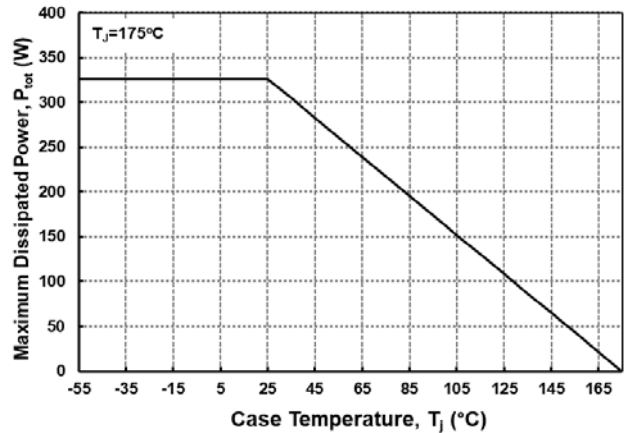

Fig 21. Transient Thermal Impedance (Junction – Case)

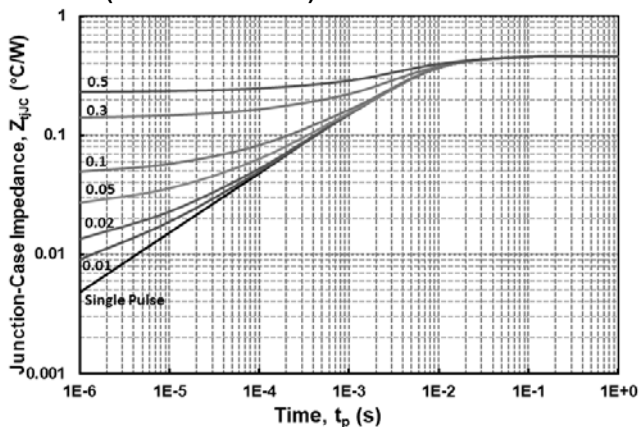

Fig 22. Safe Operating Area

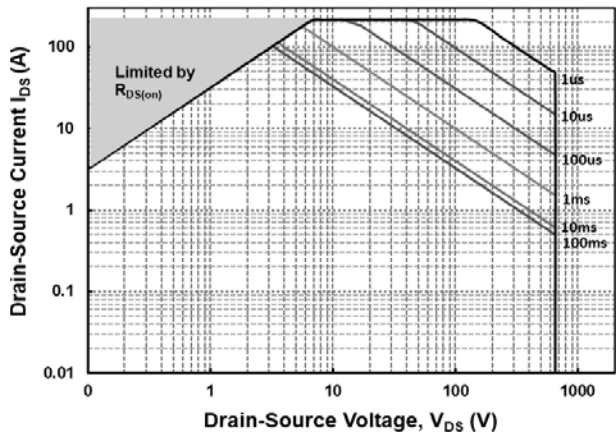

Fig 23. Clamped Inductive Switching Energy vs Drain Current (V_{DD} = 400V)

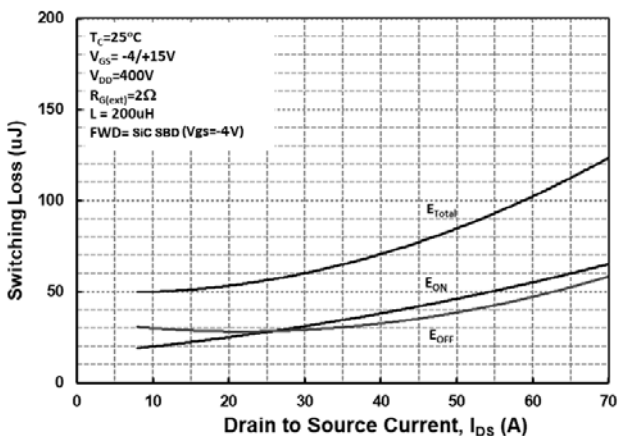
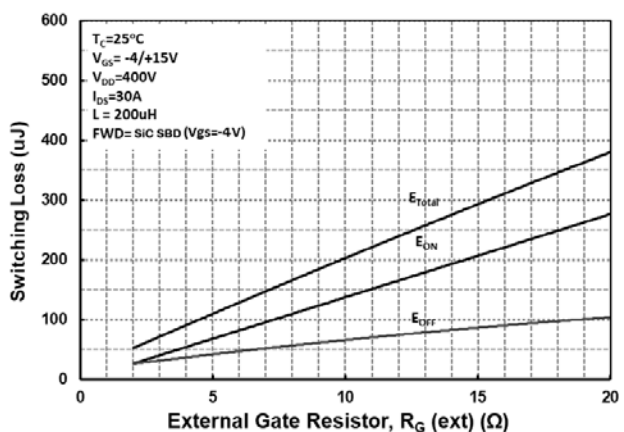
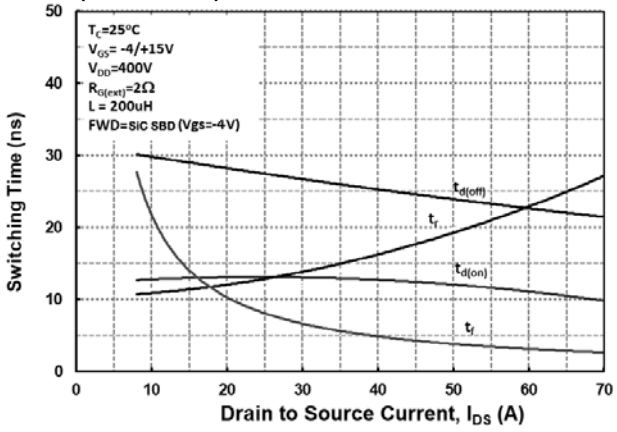
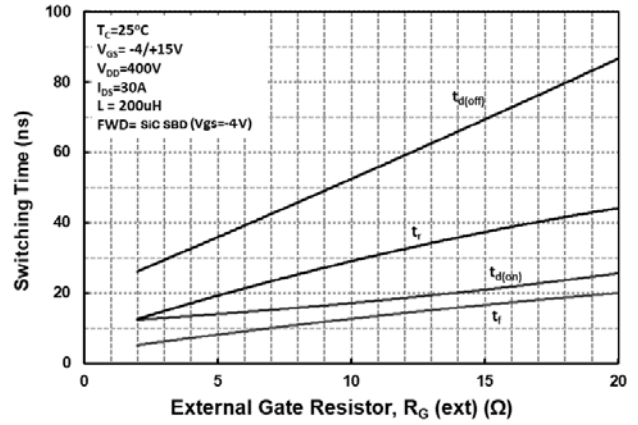

Fig 24. Clamped Inductive Switching Energy vs External Gate Resistor R_{G(ext)}



Typical Performance
Fig 25. Switching Times vs Drain Current
($V_{DD} = 400V$)

Fig 26. Switching Times vs External Gate Resistor $R_{G(ext)}$

Disclaimer

DACO Semiconductor reserves the right to make modifications, enhancements, improvements, corrections, or other changes to this document and any product described herein without prior notice. For the most up-to-date version, please visit our website.

DACO Semiconductor makes no warranty, representation, or guarantee regarding the suitability of its products for any particular purpose, nor does DACO Semiconductor assume any liability arising out of the application or use of any product or circuit, and specifically disclaims any liability, including without limitation special, consequential or incidental damages.

Purchasers are responsible for its products and applications using DACO Semiconductor products, including compliance with all laws, regulations, and safety requirements or standards, regardless of any support or application information provided by DACO Semiconductor. "Typical" parameters that may be provided in DACO Semiconductor datasheets and/or specifications can and do vary in different applications and actual performance may vary over time. All operating parameters, including "Typical" must be validated for each customer application by the customer's technical experts.

DACO Semiconductor products are not designed, authorized, or warranted to be suitable for use in life support, life-critical or safety-critical systems, or equipment, nor in applications where failure or malfunction of DACO Semiconductor's product can reasonably be expected to result in personal injury, death or severe property or environmental damage. DACO Semiconductor accepts no liability for the inclusion and/or use of DACO Semiconductor's products in such equipment or applications and therefore such inclusion and/or use is at the customer's own risk.

Purchasers who buy or use DACO Semiconductor products for any unintended or unauthorized applications are required to indemnify and absolve DACO Semiconductor, its suppliers, and distributors from any claims, costs, damages, expenses, and reasonable attorney fees arising out of, directly or indirectly, any claim of personal injury or death associated with such unintended or unauthorized use, even if such claim alleges that DACO Semiconductor was negligent regarding the design or manufacture of the part.

No part of this publication may be reproduced or transmitted in any form or by any means, electronic or mechanical, including photocopying and recording, or by any information storage and retrieval system, or otherwise, without the prior written permission of DACO Semiconductor Co., Ltd.