

SiC SCHOTTKY DIODE TYPE 450A

Features

- High surge current capable
- Zero reverse recovery current
- High bandwidth
- Temperature independent switching behavior
- VDC 1200 V

Benefits

- Unipolar rectifier
- Zero switching loss
- Higher efficiency
- Smaller heat sink
- Parallel devices without thermal runaway

Applications

- Motor drives
- Switch mode power supplies
- Ev chargers
- Solar inverters
- Welding equipment
- Power factor correction
- Diode snubber
- Automotive
- Induction heating



Dimensions in mm (1 mm = 0.0394")

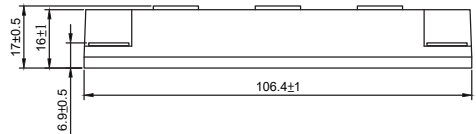
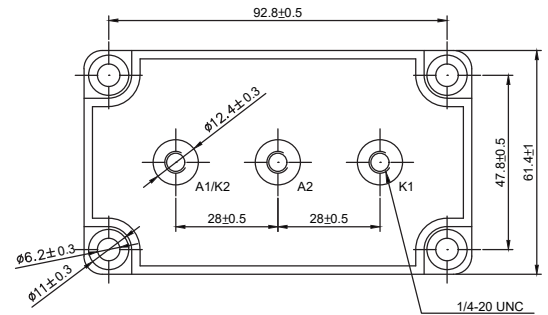

Maximum Ratings

Operating Junction Temperature : -55 °C to +175 °C

Storage Temperature : -55 °C to +175 °C

Part Number	Maximum Recurrent Peak Reverse Voltage	Maximum DC Blocking Voltage
CSRP2×450-120F1B	1200V	1200V

Maximum Rating	Symbol	Conditions	Value	Unit	
Continuous forward current (per diode)	I_F	$T_C=100\text{ }^\circ\text{C}$	450*	A	
Surge non-repetitive forward current sine halfwave (per diode)	I_{FSM}	$T_C=25\text{ }^\circ\text{C}$, $t_p=8.3\text{ ms}$	3600		
		$T_C=150\text{ }^\circ\text{C}$, $t_p=8.3\text{ ms}$	2625		
Non-repetitive peak forward current (per diode)	$I_{F,max}$	$T_C=25\text{ }^\circ\text{C}$, $t_p=10\text{ }\mu\text{s}$	16800		
		$T_C=150\text{ }^\circ\text{C}$, $t_p=10\text{ }\mu\text{s}$	10500		
Repetitive peak reverse voltage	V_{RRM}	$T_J=25\text{ }^\circ\text{C}$	1200	V	
Isolation voltage	V_{iso}	50/60 Hz, $t=1\text{min}$ $I_{ISOL} \leq 1\text{mA}$	3000	V	
Mounting torque	To heatsink To terminal	M_d	M6 1/4-20 unc	3-5 3-5	Nm
Weight			324	g	

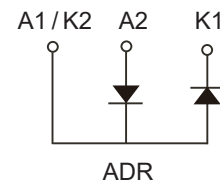

* Specification of SiC device, but output current must be limited due to size of power connectors.

Electrical Characteristics, at $T_j=25\text{ }^\circ\text{C}$, unless otherwise specified. (per diode)

Static Characteristics	Symbol	Conditions	Values			Unit
			min.	typ.	max.	
DC blocking voltage	V_{DC}		1,200	-	-	V
Diode forward voltage	V_F	$I_F=450\text{A}, T_j=25\text{ }^\circ\text{C}$	-	1.6	1.8	
		$I_F=450\text{A}, T_j=175\text{ }^\circ\text{C}$	-	2.1	2.4	
Reverse current	I_R	$V_R=1,200\text{V}, T_j=25\text{ }^\circ\text{C}$	-	100	200	μA
		$V_R=1,200\text{V}, T_j=175\text{ }^\circ\text{C}$	-	150	500	

AC Characteristics (per diode)

Static Characteristics	Symbol	Conditions	Values			Unit
			min.	typ.	max.	
Total capacitive charge	Q_{rr}	$V_R=800\text{V}, T_j=25\text{ }^\circ\text{C}$	-	1,824	-	nC
Total capacitance	C	$V_R=0\text{V}, f=1\text{ MHz}$ $T_j=25\text{ }^\circ\text{C}$	-	30,845	-	pF
		$V_R=400\text{V}, f=1\text{ MHz}$ $T_j=25\text{ }^\circ\text{C}$	-	2,311	-	
		$V_R=800\text{V}, f=1\text{ MHz}$ $T_j=25\text{ }^\circ\text{C}$	-	1,736	-	

Thermal Characteristics (per diode)

Static Characteristics	Symbol	Values	Unit
		typ.	
Thermal resistance from junction to case	$R_{\theta JC}$	0.068	$^\circ\text{C/W}$

Typical Performance

Forward Characteristics (parameterized on T_j)

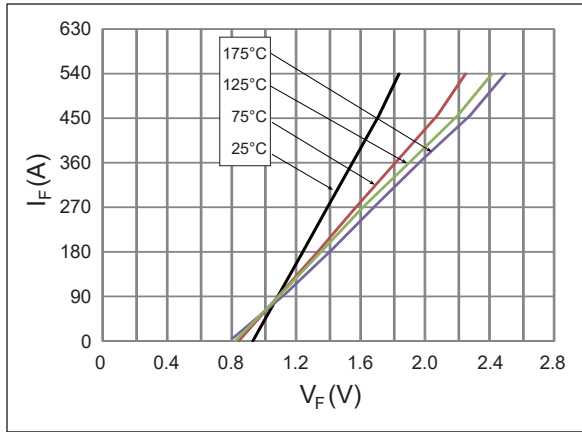

Reverse Characteristics (parameterized on T_j)

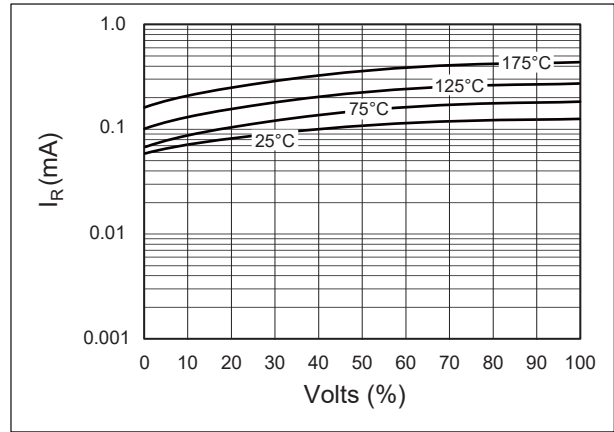

Capacitance

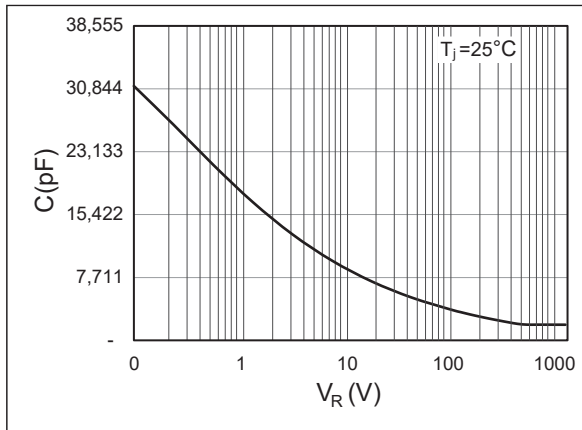

Current Derating

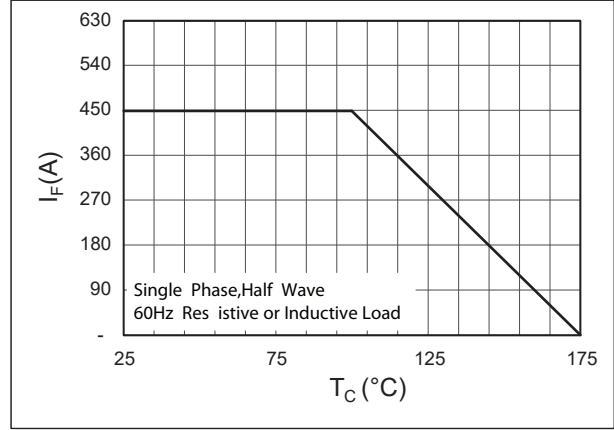

Recovery Charge

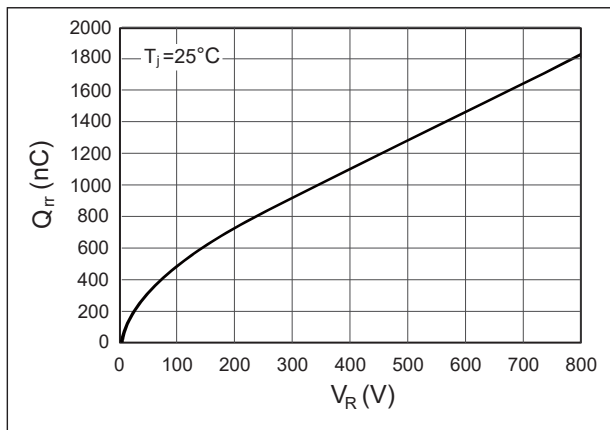

Forward Surge Current

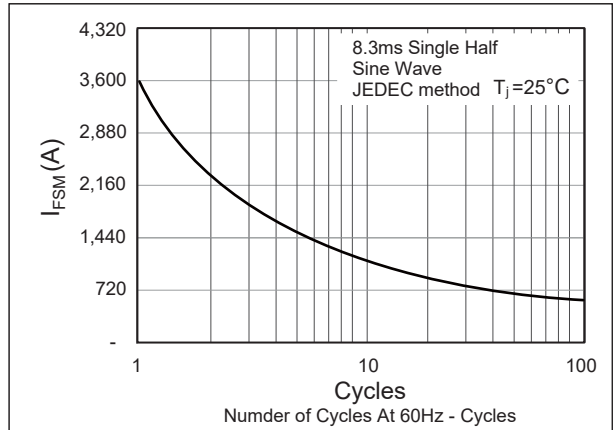

Disclaimer

DACO Semiconductor reserves the right to make modifications, enhancements, improvements, corrections, or other changes to this document and any product described herein without prior notice.

DACO Semiconductor makes no warranty, representation, or guarantee regarding the suitability of its products for any particular purpose, nor does DACO Semiconductor assume any liability arising out of the application or use of any product or circuit, and specifically disclaims any liability, including without limitation special, consequential or incidental damages.

Purchasers are responsible for its products and applications using DACO Semiconductor products, including compliance with all laws, regulations, and safety requirements or standards, regardless of any support or application information provided by DACO Semiconductor. “Typical” parameters that may be provided in DACO Semiconductor datasheets and/or specifications can and do vary in different applications and actual performance may vary over time. All operating parameters, including “Typical” must be validated for each customer application by the customer’s technical experts.

DACO Semiconductor products are not designed, authorized, or warranted to be suitable for use in life support, life-critical or safety-critical systems, or equipment, nor in applications where failure or malfunction of DACO Semiconductor’s product can reasonably be expected to result in personal injury, death or severe property or environmental damage. DACO Semiconductor accepts no liability for the inclusion and/or use of DACO Semiconductor’s products in such equipment or applications and therefore such inclusion and/or use is at the customer’s own risk.

Purchasers who buy or use DACO Semiconductor products for any unintended or unauthorized applications are required to indemnify and absolve DACO Semiconductor, its suppliers, and distributors from any claims, costs, damages, expenses, and reasonable attorney fees arising out of, directly or indirectly, any claim of personal injury or death associated with such unintended or unauthorized use, even if such claim alleges that DACO Semiconductor was negligent regarding the design or manufacture of the part.

No part of this publication may be reproduced or transmitted in any form or by any means, electronic or mechanical, including photocopying and recording, or by any information storage and retrieval system, or otherwise, without the prior written permission of DACO Semiconductor Co., Ltd.