



SiC Schottky Diode Full Bridge Power Module

Features

- Zero reverse recovery
- Zero forward recovery
- Temperature-independent switching behavior
- Positive temperature coefficient on VF
- Very low stray inductance
- High level of integration

Benefits

- Outstanding performance at high-frequency operation
- Direct mounting to heatsink (isolated package)
- Low junction-to-case thermal resistance
- RoHS compliant

Applications

- Switch mode power supplies rectifier
- Induction heating
- Welding equipment
- High-speed rectifiers

Preliminary

$V_{RRM}=1,700V$
 $I_F=50A@T_c=135^{\circ}C$

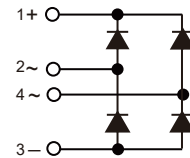
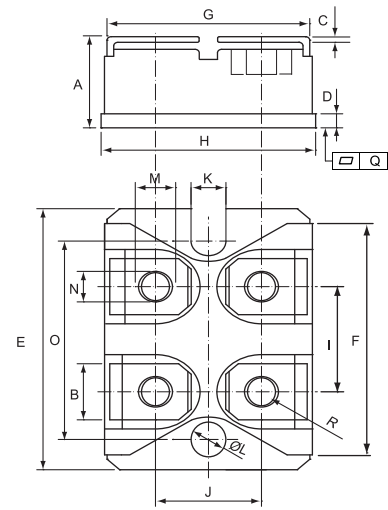
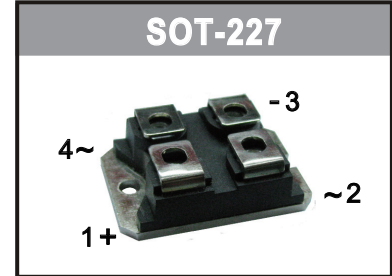

Maximum Ratings

Part Number	Maximum Recurrent Peak Reverse Voltage	Maximum DC Blocking Voltage
CSRI4×50-170L1B	1700V	1700V

Maximum Rating	Symbol	Conditions	Value	Unit
Continuous forward current (per diode)	I_F	$T_c=25^{\circ}C$	120	A
		$T_c=125^{\circ}C$	60	
		$T_c=135^{\circ}C$	50	
Non-repetitive peak forward surge current (per diode)	I_{FSM}	$T_c=25^{\circ}C$, $t_p=8.3ms$ half sine wave	400	A
		$T_c=150^{\circ}C$, $t_p=8.3ms$ half sine wave	250	
		$T_c=25^{\circ}C$, $t_p=10\mu s$ pulse	1600	
Repetitive peak forward surge current (per diode)	I_{FRM}	$T_c=25^{\circ}C$, $t_p=10ms$ half sine wave, $D=0.1$	320	A
		$T_c=125^{\circ}C$, $t_p=10ms$ half sine wave, $D=0.1$	176	
DC blocking voltage	V_R	$T_j=25^{\circ}C$	1700	V
Repetitive peak reverse voltage	V_{RRM}	$T_j=25^{\circ}C$	1700	V
Isolation voltage between All Terminals and Baseplate	V_{iso}	50/60Hz, RMS $I_{ISOL} \leq 1mA$	2500	V
Operating junction and storage temperature	T_j		175	$^{\circ}C$
	T_{stg}		-55 to 175	
Mounting torque		To heatsink	1.3	Nm
		To terminal	1.1	

	DIMENSIONS			
	INCHES		MM	
	MIN	MAX	MIN	MAX
A	0.460	0.483	11.68	12.28
B	0.307	0.323	7.80	8.20
C	0.030	0.033	0.75	0.85
D	0.071	0.081	1.80	2.05
E	1.488	1.504	37.80	38.20
F	1.248	1.260	31.70	32.00
G	0.917	0.957	23.30	24.30
H	0.996	1.008	25.30	25.60
I	0.579	0.602	14.70	15.30
J	0.492	0.516	12.50	13.10
K	0.161	0.169	4.10	4.30
L	0.161	0.169	4.10	4.30
M	0.181	0.197	4.60	5.00
N	0.165	0.181	4.20	4.60
O	1.181	1.197	30.00	30.40
Q	-0.002	0.004	-0.05	0.10
R	M4*8			



Electrical Characteristics, at $T_j=25\text{ }^\circ\text{C}$, unless otherwise specified. (per diode)

Static Characteristics	Symbol	Conditions	Values			Unit
			min.	typ.	max.	
DC blocking voltage	V_{DC}		1,700	-	-	V
Diode forward voltage	V_F	$I_F=50\text{A}, T_j=25\text{ }^\circ\text{C}$	-	1.6	1.8	V
		$I_F=50\text{A}, T_j=175\text{ }^\circ\text{C}$	-	2.4	2.9	
Reverse current	I_R	$V_R=1,700\text{V}, T_j=25\text{ }^\circ\text{C}$	-	30	60	μA
		$V_R=1,700\text{V}, T_j=175\text{ }^\circ\text{C}$	-	60	250	

AC Characteristics (per diode)

Static Characteristics	Symbol	Conditions	Values			Unit
			min.	typ.	max.	
Total capacitive charge	Q_{rr}	$V_R=800\text{V}$ $I_F=50\text{A}, T_j=25\text{ }^\circ\text{C}$	-	133.9	-	nC
Total capacitance	C	$V_R=0\text{V}, f=1\text{ MHz}$ $T_j=25\text{ }^\circ\text{C}$	-	2,874	-	pF
		$V_R=800\text{V}, f=1\text{ MHz}$ $T_j=25\text{ }^\circ\text{C}$	-	200	-	
		$V_R=1000\text{V}, f=1\text{ MHz}$ $T_j=25\text{ }^\circ\text{C}$	-	199	-	

Thermal Characteristics (per diode)

Static Characteristics	Symbol	Values	Unit
		typ.	
Thermal resistance from junction to case	$R_{\theta JC}$	0.28	$^\circ\text{C/W}$



Typical Performance

Forward Characteristics (parameterized on T_j)

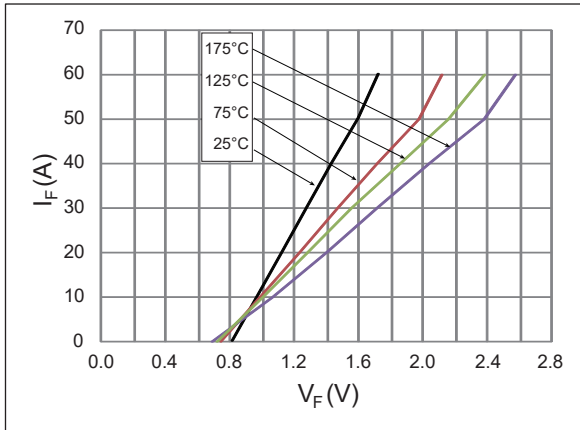

Reverse Characteristics (parameterized on T_j)

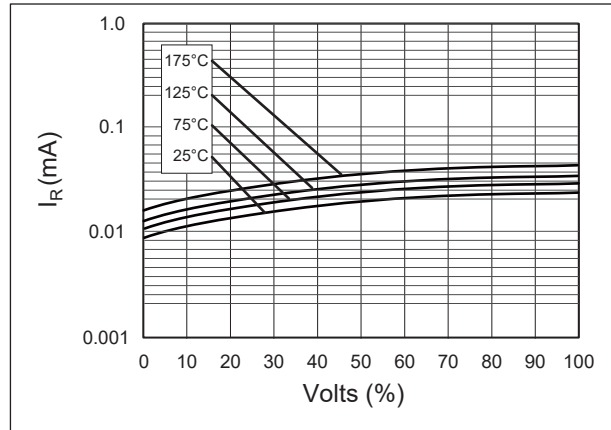

Capacitance

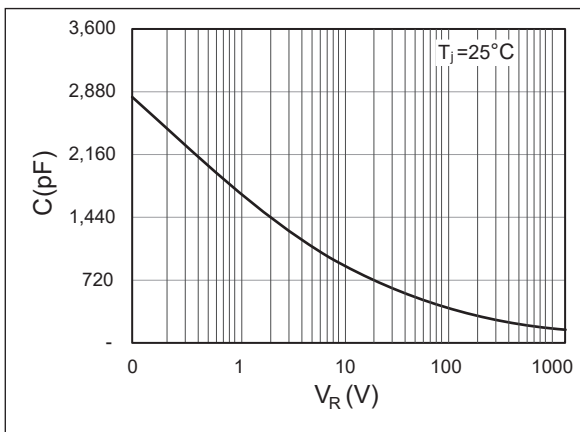

Current Derating

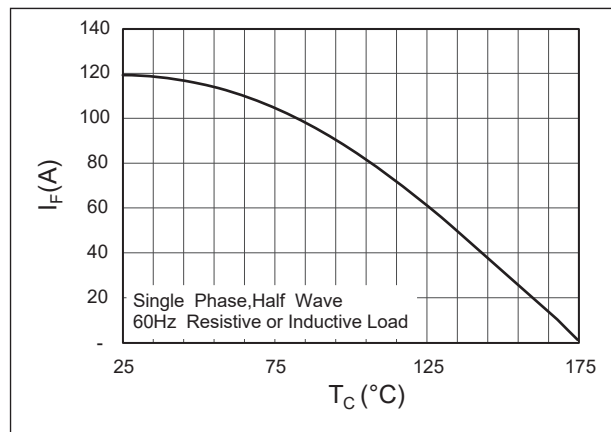

Recovery Charge

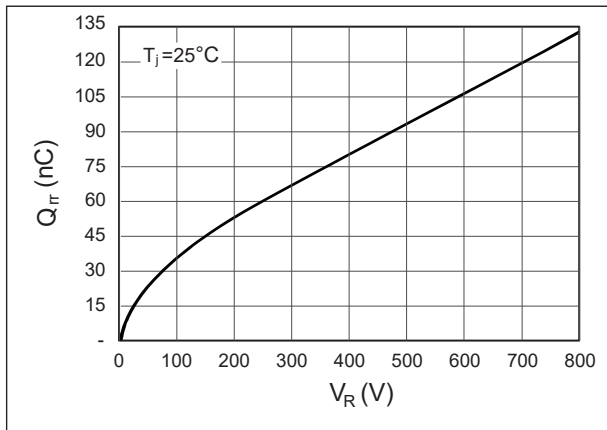

Forward Surge Current

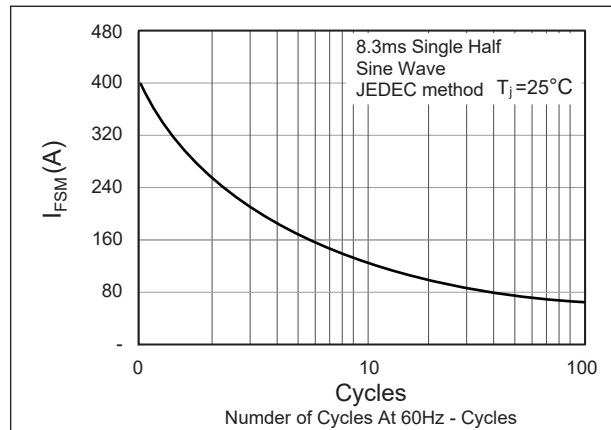



Disclaimer

DACO Semiconductor reserves the right to make modifications, enhancements, improvements, corrections, or other changes to this document and any product described herein without prior notice.

DACO Semiconductor makes no warranty, representation, or guarantee regarding the suitability of its products for any particular purpose, nor does DACO Semiconductor assume any liability arising out of the application or use of any product or circuit, and specifically disclaims any liability, including without limitation special, consequential or incidental damages.

Purchasers are responsible for its products and applications using DACO Semiconductor products, including compliance with all laws, regulations, and safety requirements or standards, regardless of any support or application information provided by DACO Semiconductor. “Typical” parameters that may be provided in DACO Semiconductor datasheets and/or specifications can and do vary in different applications and actual performance may vary over time. All operating parameters, including “Typical” must be validated for each customer application by the customer’s technical experts.

DACO Semiconductor products are not designed, authorized, or warranted to be suitable for use in life support, life-critical or safety-critical systems, or equipment, nor in applications where failure or malfunction of DACO Semiconductor’s product can reasonably be expected to result in personal injury, death or severe property or environmental damage. DACO Semiconductor accepts no liability for the inclusion and/or use of DACO Semiconductor’s products in such equipment or applications and therefore such inclusion and/or use is at the customer’s own risk.

Purchasers who buy or use DACO Semiconductor products for any unintended or unauthorized applications are required to indemnify and absolve DACO Semiconductor, its suppliers, and distributors from any claims, costs, damages, expenses, and reasonable attorney fees arising out of, directly or indirectly, any claim of personal injury or death associated with such unintended or unauthorized use, even if such claim alleges that DACO Semiconductor was negligent regarding the design or manufacture of the part.

No part of this publication may be reproduced or transmitted in any form or by any means, electronic or mechanical, including photocopying and recording, or by any information storage and retrieval system, or otherwise, without the prior written permission of DACO Semiconductor Co., Ltd.