



SiC SCHOTTKY DIODE TYPE 2×100A

Preliminary

Features

- High surge current capable
- Zero reverse recovery current
- High bandwidth
- Isolation type package
- Temperature Independent Switching Behavior
- VDC 650 V
- I_F (T_C<135°C) 2×100 A

Benefits

- Unipolar rectifier
- Zero switching loss
- Higher efficiency
- Smaller heat sink
- Parallel devices without thermal runaway

Applications

- Motor drives
- Switch mode power supplies
- Ev chargers
- Solar inverters
- Welding equipment
- Power factor correction
- Diode snubber
- Automotive
- induction heating

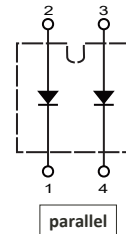
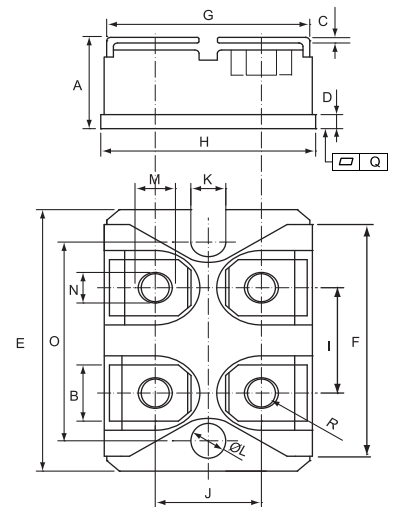
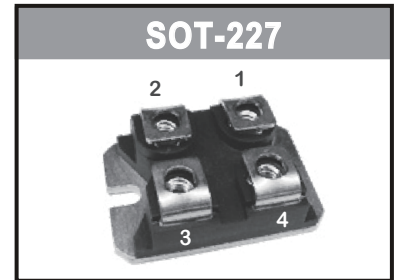

parallel

Maximum Ratings

Operating Junction Temperature : - 55 °C to +175 °C

Storage Temperature : -55 °C to +175 °C

Part Number	Maximum Recurrent Peak Reverse Voltage	Maximum DC Blocking Voltage
CSRI2×100-065P2B	650V	650V

Maximum Rating	Symbol	Conditions	Value	Unit
Continuous forward current (per diode)	I _F	T _C =135 °C	100	A
Surge non-repetitive forward current sine halfwave (per diode)	I _{FSM}	T _C =25 °C, t _p =8.3 ms	800	
		T _C =150 °C, t _p =8.3 ms	500	
Non-repetitive peak forward current (per diode)	I _{F,max}	T _C =25 °C, t _p =10 μs	3200	
		T _C =150 °C, t _p =10 μs	2000	
Repetitive peak reverse voltage	V _{RRM}	T _J =25 °C	650	V
Isolation voltage between All Terminals and Baseplate	V _{iso}	50/60 Hz, t=1min I _{ISOL} ≤ 1mA	2500	V
Mounting torque		To heatsink	1.3	Nm
		To terminal	1.1	

	DIMENSIONS			
	INCHES		MM	
	MIN	MAX	MIN	MAX
A	0.460	0.483	11.68	12.28
B	0.307	0.323	7.80	8.20
C	0.030	0.033	0.75	0.85
D	0.071	0.081	1.80	2.05
E	1.488	1.504	37.80	38.20
F	1.248	1.260	31.70	32.00
G	0.917	0.957	23.30	24.30
H	0.996	1.008	25.30	25.60
I	0.579	0.602	14.70	15.30
J	0.492	0.516	12.50	13.10
K	0.161	0.169	4.10	4.30
L	0.161	0.169	4.10	4.30
M	0.181	0.197	4.60	5.00
N	0.165	0.181	4.20	4.60
O	1.181	1.197	30.00	30.40
Q	-0.002	0.004	-0.05	0.10
R	M4*8			

**Electrical Characteristics**, at $T_j=25\text{ }^\circ\text{C}$, unless otherwise specified. (per diode)

Static Characteristics	Symbol	Conditions	Values			Unit
			min.	typ.	max.	
DC blocking voltage	V_{DC}		650	-	-	V
Diode forward voltage	V_F	$I_F=100\text{A}$, $T_j=25\text{ }^\circ\text{C}$	-	1.50	1.70	
		$I_F=100\text{A}$, $T_j=175\text{ }^\circ\text{C}$	-	1.70	2.00	
Reverse current	I_R	$V_R=650\text{V}$, $T_j=25\text{ }^\circ\text{C}$	-	60	100	μA
		$V_R=650\text{V}$, $T_j=175\text{ }^\circ\text{C}$	-	100	500	

AC Characteristics (per diode)

Characteristics	Symbol	Conditions	Values			Unit
			min.	typ.	max.	
Total capacitive charge	Q_{rr}	$V_R=400\text{V}$, $T_j=25\text{ }^\circ\text{C}$	-	210	-	nC
Total capacitance	C	$V_R=0\text{V}$, $f=1\text{ MHz}$ $T_j=25\text{ }^\circ\text{C}$	-	4000	-	pF
		$V_R=200\text{V}$, $f=100\text{ KHz}$ $T_j=25\text{ }^\circ\text{C}$	-	510	-	
		$V_R=400\text{V}$, $f=100\text{ KHz}$ $T_j=25\text{ }^\circ\text{C}$	-	492	-	

Thermal Characteristics (per diode)

Characteristics	Symbol	Values	Unit
		typ.	
Thermal resistance from junction to case	$R_{\theta JC}$	0.14	$^\circ\text{C/W}$



Typical Performance

Forward Characteristics (parameterized on T_j)

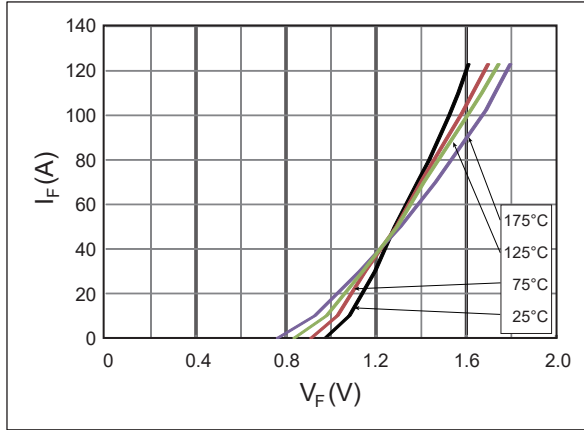

Reverse Characteristics (parameterized on T_j)

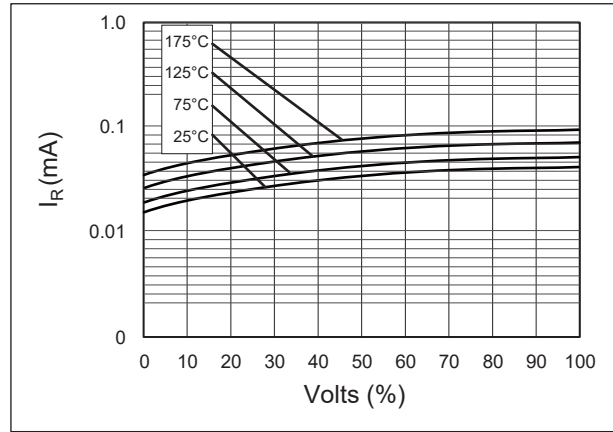

Capacitance

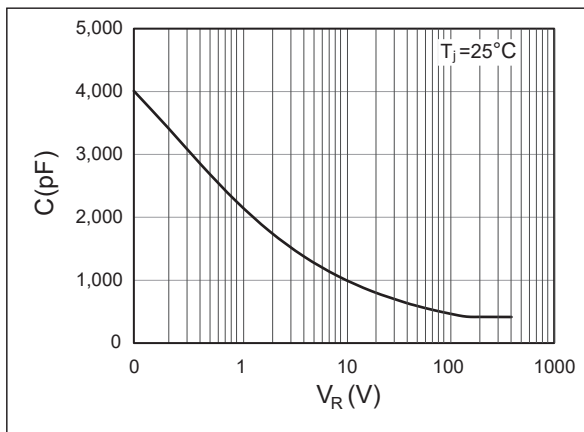

Current Derating

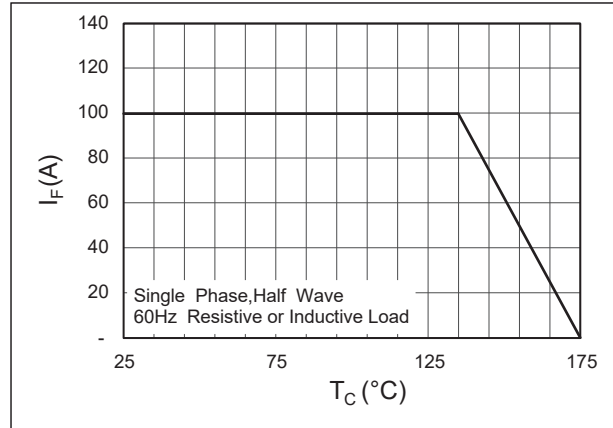

Recovery Charge

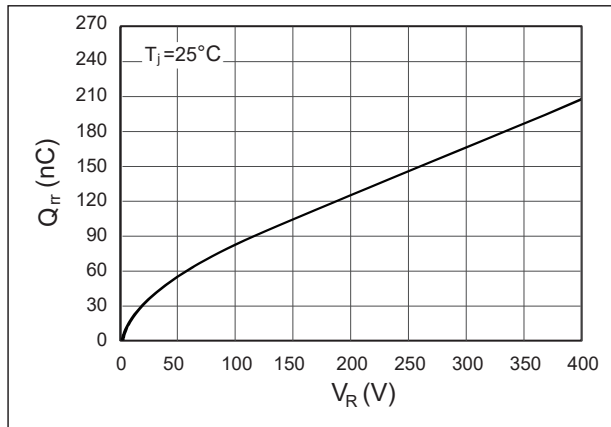

Forward Surge Current

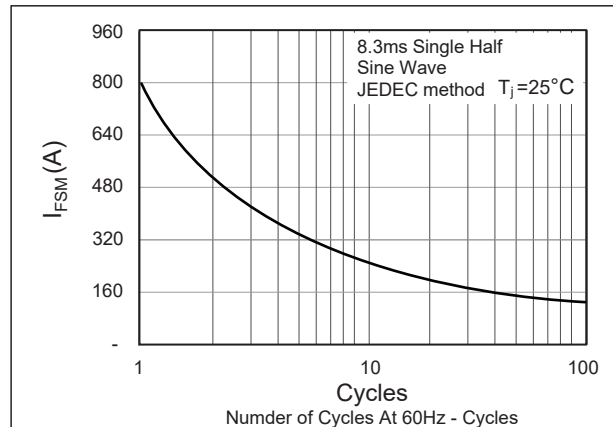



Disclaimer

DACO Semiconductor reserve the right to make modifications, enhancements, improvements, corrections or other changes without further notice to this document and any product described herein.

DACO Semiconductor makes no warranty, representation or guarantee regarding the suitability of its products for any particular purpose, nor does DACO Semiconductor assume any liability arising out of the application or use of any product or circuit, and specifically disclaims any and all liability, including without limitation special, consequential or incidental damages.

Purchasers is responsible for its products and applications using DACO Semiconductor products, including compliance with all laws, regulations and safety requirements or standards, regardless of any support or applications information provided by DACO Semiconductor. "Typical" parameters which may be provided in DACO Semiconductor data sheets and/or specifications can and do vary in different applications and actual performance may vary over time. All operating parameters, including "Typicals" must be validated for each customer application by customer's technical experts.

DACO Semiconductor products are not designed, authorized or warranted to be suitable for use in life support, life-critical or safety-critical systems or equipment, nor in applications where failure or malfunction of DACO Semiconductor's product can reasonably be expected to result in personal injury, death or severe property or environmental damage. DACO Semiconductor accept no liability for inclusion and/or use of DACO Semiconductor's products in such equipment or applications and therefore such inclusion and/or use is at the customer's own risk.

Purchasers buy or use DACO Semiconductor products for any such unintended or unauthorized application, Purchasers shall indemnify and hold DACO Semiconductor and its suppliers and distributors harmless against all claims, costs, damages, and expenses, and reasonable attorney fees arising out of, directly or indirectly, any claim of personal injury or death associated with such unintended or unauthorized use, even if such claim alleges that DACO Semiconductor was negligent regarding the design or manufacture of the part.

No part of this publication may be reproduced or transmitted in any form or by any means, electronic or mechanical, including photocopying and recording, or any information storage or retrieval system, or otherwise, without the prior written permission of DACO Semiconductor Co., Ltd.